

**GLOCK Semiautomatic
"SAFE ACTION" Pistols**

**GLOCK 17, 19, 20,
21, 22, 23 & 17L**

January 1992

GLOCK ARMORER'S MANUAL



PERFECTION

GLOCK 17-Best Pistol Award of Merit
American Firearms Industry 1987

GLOCK 17 NATO Stock
No. 1005/25/133/6775

TABLE OF CONTENTS

I. Introduction	5
Exploded Drawings and Parts List	6
II. Safety	8
Safety Devices—Trigger Safety, Firing Pin Safety, Safety Function of the Trigger Mechanism Housing	8
III. Technical Data—Specifications	10
IV. Ammunition Specifications for Glock Pistols	12
V. Field Stripping	13
Magazine Removal	14
Slide Removal	15
Barrel Removal	16
Magazine Disassembly	18
VI. Preventative Maintenance	19
Cleaning the Field Stripped Firearm	19
Lubrication	20
Function Testing the Trigger Safety	21
Function Testing the Firing Pin Safety	21
VII. Slide Disassembly	22
Firing Pin Assembly Removal	23
Extractor Removal	24
Firing Pin Assembly Disassembly	26
VIII. Receiver Disassembly	27
Trigger Pin Removal	28
Slide Stop Lever Removal	28
Locking Block Removal	29
Trigger Mechanism Housing Pin Removal	29
Trigger Assembly Removal	30
Trigger Assembly Take-down	31
New York Trigger Spring	33
Slide Lock Removal	34
Slide Lock Spring Removal	34
Magazine Catch Removal	35
Magazine Catch Spring Removal	35
IX. Reassembly Procedures	36
X. Front and Rear Sight Removal & Installation	38
Front Sight Removal	38
Front Sight Installation	38
Rear Sight Removal	38
Rear Sight Installation	38
Sight Installation Device	39
Service Procedures and Trouble Shooting	42
Glock Parts and Accessories: Glock 17	44
Glock Parts and Accessories: Glock 17L	45
Glock Parts and Accessories: Glock 19	46
Glock Parts and Accessories: Glock 20	47
Glock Parts and Accessories: Glock 21	48
Glock Parts and Accessories: Glock 22	49
Glock Parts and Accessories: Glock 23	50

GLOCK "SAFE ACTION" PISTOLS



GLOCK 17



GLOCK 19



GLOCK 20



GLOCK 21



GLOCK 22



GLOCK 23



GLOCK 17L

THIS ARMORER'S MANUAL IS TO BE SUPPLEMENTED BY TECHNICAL BULLETINS

Information and Specifications contained within this manual may change without notification.

This manual provides basic service and back-up information for certified GLOCK armorers, and is not intended for use by other people.

Certification can only be granted by GLOCK after attending a GLOCK armorer's school.

GLOCK cannot be held responsible for any misinterpretation of the instructions in this manual that can lead to improper functioning of the pistol.

For additional information and service guidelines contact GLOCK for your nearest certified field representative.

I. INTRODUCTION

All GLOCK pistols are a product of modern technology, incorporating many innovative design features which result in ease of operation, extreme reliability, simple function, reduced maintenance, durability and light weight. Mr. GLOCK was the first person to successfully produce a polymer handgun receiver and marry it to a strong, all steel slide and barrel. In addition to new materials and manufacturing methods, the GLOCK pistol has an action which combines the best characteristics of the traditional double and single action pistols, creating what has become known as the "Safe Action" system.

Safe, simple operation, reliability and accuracy were primary design criteria. To achieve safety with simplicity, three independent safeties sequentially disengage as the pistol's trigger is pulled to its rear-most position. These safeties automatically reset themselves once the shooter removes his finger from the trigger. GLOCK pistols combine the safety and simplicity of revolver-like operation with a constant double action trigger pull, high magazine capacity, rapid recovery and the reduced recoil of a modern, semi-automatic pistol.

GLOCK currently has available for distribution to police agencies: The GLOCK 17 (9mm), the GLOCK 19 (9mm compact), the GLOCK 22 (.40 caliber), the GLOCK 23 (.40 caliber compact), the GLOCK 20 (10mm), and the GLOCK 21 (.45 ACP caliber).



Figure 1

This manual provides maintenance and technical information for certified GLOCK armorers. It contains numerous pictures, each one showing exactly how a specific procedure is to be carried out. This makes maintenance extremely simple and straightforward. A unique feature of the GLOCK pistol is that all parts generally are interchangeable within the same model—no hand fitting, filing or polishing is required or advised.

Prior to the service and maintenance section of this manual is a section devoted to SAFETY as it relates to the GLOCK pistol (Read Safety Rules on page 8). Read and be familiar with this information prior to performing any maintenance on the pistol.

Wear safety glasses while performing maintenance.

The terms: right & left, front (muzzle) & rear, top & bottom, up & down and forward & backward, as used in this manual refer to the pistol when being held in shooting position as seen by the shooter.

Notes: _____

Exploded Drawing and Parts List for Glock 17 NATO Stock No. 1005/25/133/6775

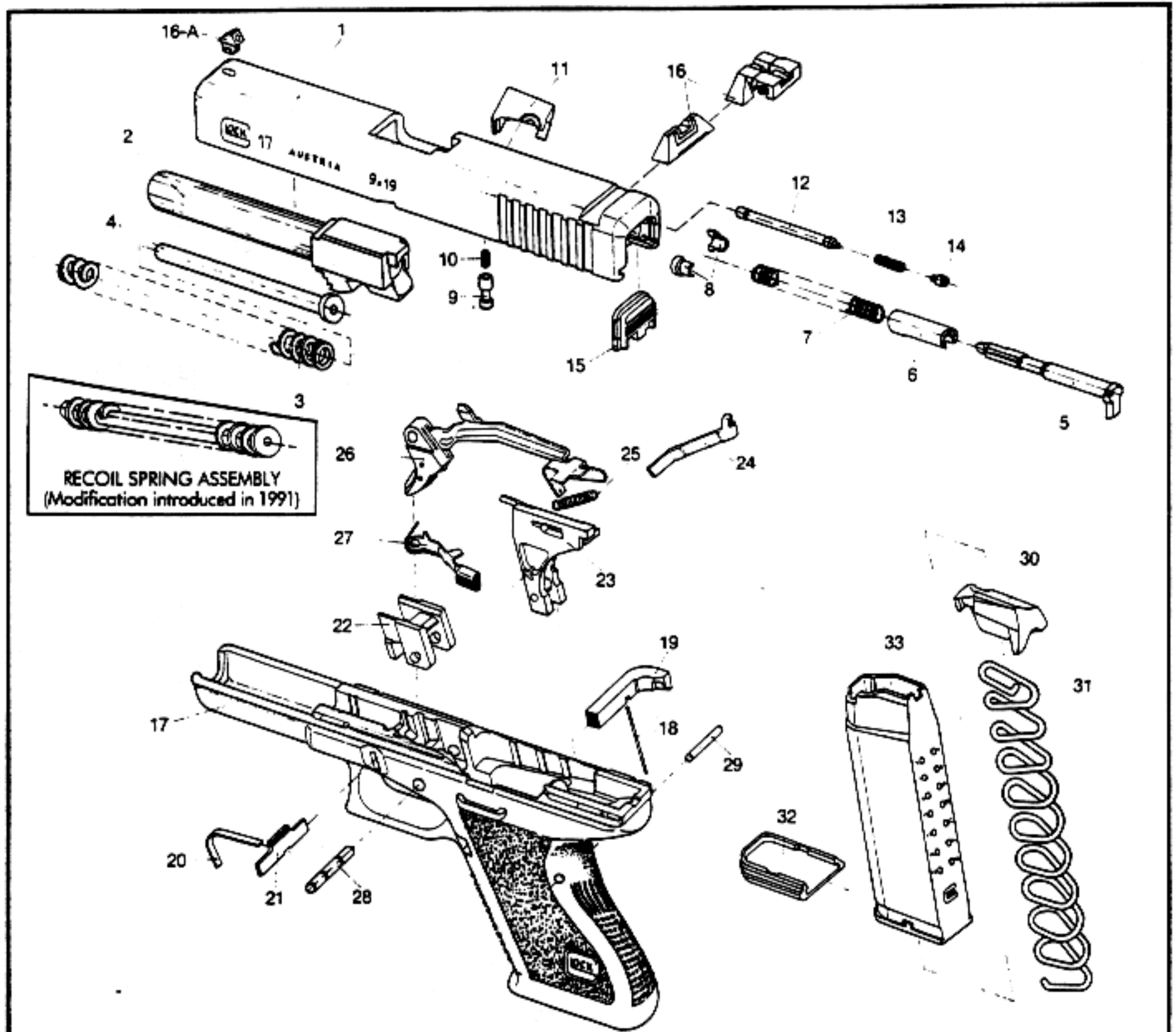
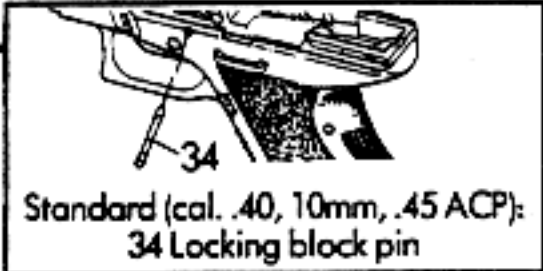

Figure 2



Standard (cal. .40, 10mm, .45 ACP):
34 Locking block pin



Cal. .9mm, .40, .45 ACP:
32A Magazine insert



Optional (for part #25):
25A New York Trigger Spring
25B New York Trigger Spring Plus

- | | | |
|---------------------------------------|---|-----------------------------------|
| 1 Slide | 14 Spring-loaded bearing | 25-A New York Trigger Spring |
| 2 Barrel | 15 Slide cover plate | 25-B New York Trigger Spring Plus |
| 3 Recoil spring | 16 Rear sight | 26 Trigger with trigger bar |
| 4 Recoil spring tube | 16a Front sight | 27 Slide stop lever |
| 5 Firing pin | 17 Receiver | 28 Trigger pin |
| 6 Spacer sleeve | 18 Magazine catch spring | 29 Trigger mechanism housing pin |
| 7 Firing pin spring | 19 Magazine catch | 30 Follower |
| 8 Spring cups | 20 Slide lock spring | 31 Magazine spring |
| 9 Firing pin safety | 21 Slide lock | 32 Magazine floor plate |
| 10 Firing pin safety spring | 22 Locking block | 32-A Magazine insert |
| 11 Extractor | 23 Trigger mechanism housing with ejector | 33 Magazine tube |
| 12 Extractor depressor plunger | 24 Connector | 34 Locking block pin |
| 13 Extractor depressor plunger spring | 25 Trigger spring | |

Note: Refer to parts order list pages 44-50.

Parts That Do Not Interchange with Glock 17 Parts

GLOCK 17L

- 1 Slide
- 2 Barrel
- 19 Magazine Catch

GLOCK 19

- 1 Slide
- 2 Barrel
- 3 Recoil spring
- 4 Recoil spring tube
- 17 Receiver
- 20 Slide lock spring
- 22 Locking block
- 26 Trigger with trigger bar
- 27 Slide stop lever
- 31 Magazine spring
- 33 Magazine tube

GLOCK 20

- 1 Slide
- 2 Barrel
- 3 Recoil spring
- 4 Recoil spring tube
- 5 Firing pin
- 11 Extractor
- 12 Extractor depressor plunger
- 17 Receiver
- 19 Magazine catch
- 20 Slide lock spring
- 21 Slide lock
- 22 Locking block
- 23 Trigger mechanism housing with ejector
- 26 Trigger with trigger bar
- 27 Slide stop lever
- 30 Follower
- 32 Magazine floor plate
- 33 Magazine tube
- 34 Locking block pin

GLOCK 21

- 1 Slide
- 2 Barrel
- 3 Recoil spring
- 4 Recoil spring tube
- 5 Firing pin
- 9 Firing pin safety
- 11 Extractor
- 12 Extractor depressor plunger
- 17 Receiver
- 19 Magazine catch
- 20 Slide lock spring
- 21 Slide lock
- 22 Locking block
- 23 Trigger mechanism housing with ejector
- 26 Trigger with trigger bar
- 27 Slide stop lever
- 30 Follower
- 32 Magazine floor plate
- 33 Magazine tube
- 34 Locking block pin

GLOCK 22

- 1 Slide
- 2 Barrel
- 3 Recoil spring
- 4 Recoil spring tube
- 5 Firing pin
- 17 Receiver
- 22 Locking block
- 23 Trigger mechanism housing with ejector
- Do not put trigger mechanism housing with ejector from a GLOCK 17 or GLOCK 19 into the GLOCK 22. Ejector may hit primer causing round to fire.**
- 27 Slide stop lever
- 30 Follower
- 33 Magazine tube
- 34 Locking block pin

GLOCK 23

- 1 Slide
- 2 Barrel
- 3 Recoil spring
- 4 Recoil spring tube
- 5 Firing pin
- 17 Receiver
- 20 Slide lock spring
- 22 Locking block
- 23 Trigger mechanism housing with ejector
- Do not put trigger mechanism housing with ejector from a GLOCK 17 or GLOCK 19 into the GLOCK 23. Ejector may hit primer causing round to fire.**
- 26 Trigger with trigger bar
- 27 Slide stop lever
- 30 Follower
- 31 Magazine spring
- 33 Magazine tube
- 34 Locking block pin

Notes: _____

II. SAFETY

Basic Firearm Safety Rules

- #1 Always keep the firearm pointed in a safe direction.
- #2 Handle all firearms as if they were loaded.
- #3 The trigger finger stays out of the trigger guard until the firearm is on target *and* the decision to fire has been made.
- #4 Make sure the firearm is in good working order and the barrel clear of obstructions.
- #5 Always check your target, backstop and the surrounding area before firing.
- #6 Quality ear and eye protection should always be worn when shooting or observing.
- #7 When storing a firearm, **the firearm should be unloaded**, secured in a safe storage case and out of the reach of children and untrained adults.
- #8 Only use ammunition recommended by the firearm manufacturer and always check caliber and condition of ammunition before loading the firearm.
- #9 Firearm transportation is regulated by Federal, State and local laws. Always transport your firearm in a safe, unloaded condition and in accordance with applicable laws.

- #10 Certain medications, alcohol and firearms do not mix. Never allow anyone to use firearms when under the influence of drugs or alcohol.
- #11 The safe and rational use of a firearm relies on common sense and proper training of the user. Follow safety rules and *think* before using a firearm.
- #12 Thoroughly read and understand the users manual that is supplied with your firearm. Never use any firearm unless you completely understand its operation and safety features.

Safety Devices

The weapon has no conventional, externally-located safety lever. Therefore make sure that the trigger is touched only when you intend to fire or when verified empty, in order to perform maintenance.

1. Trigger Safety

It is incorporated into the trigger (26) in the form of a lever, and in the untouched state blocks the trigger from being moved backwards.

To fire the pistol, both the trigger safety and the trigger must be depressed at the same time.

If the trigger safety is not depressed, then the trigger will not move to the rear

and the pistol will not fire. This is designed to prevent the trigger from going to the rear when dropped.

2. Firing Pin Safety:

A spring-loaded pin (9) projects into the firing pin cut-out, and blocks it. This safety is only released while the trigger is pulled.

3. Safety Function of the Trigger Mechanism Housing (Drop Safety):

The trigger bar is pushed onto the safety ramp by the firing pin.

THE SAFETY DEVICES 1, 2 and 3 above are designed to prevent the weapon from unintentional discharge, if dropped from up to 6.5 ft., exceeding NATO standards.

Special Warning:

In case the trigger safety proves to be ineffective for any reason, DANGER of an unintentional discharge exists. THE WEAPON IS THEN TO BE IMMEDIATELY UNLOADED AND RESTRICTED FROM FURTHER USE. MAKE SURE THAT YOUR WEAPON IS PROPERLY REPAIRED AND CHECKED BY GLOCK OR AUTHORIZED PERSONNEL BEFORE USING IT AGAIN!

Notes: _____

The vertical extension of the trigger bar is forward of the firing pin safety. Until the trigger safety is disengaged, the trigger bar is prevented from moving rearward and the firing pin safety remains in the safe (firing pin blocked) position (Figure 3).

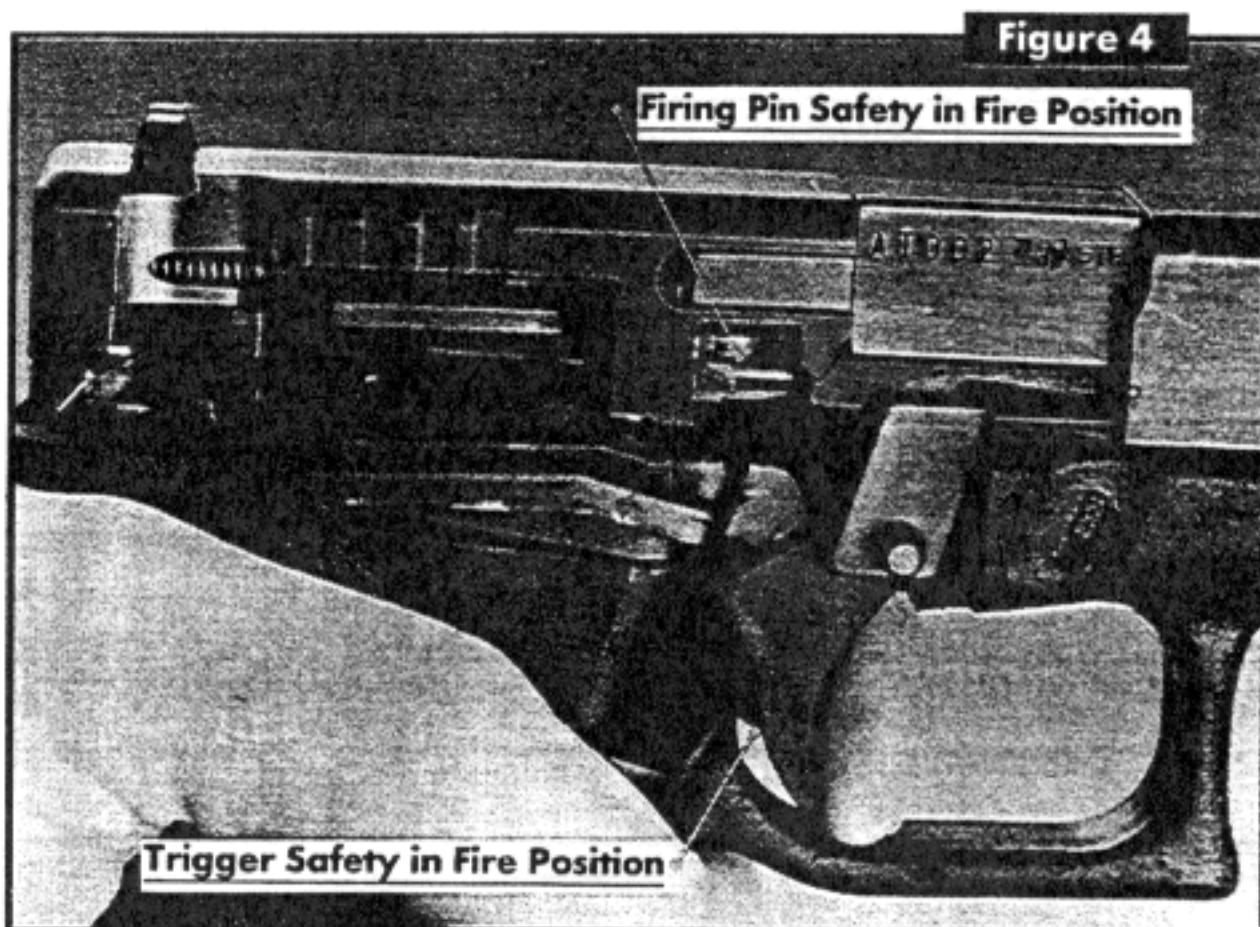
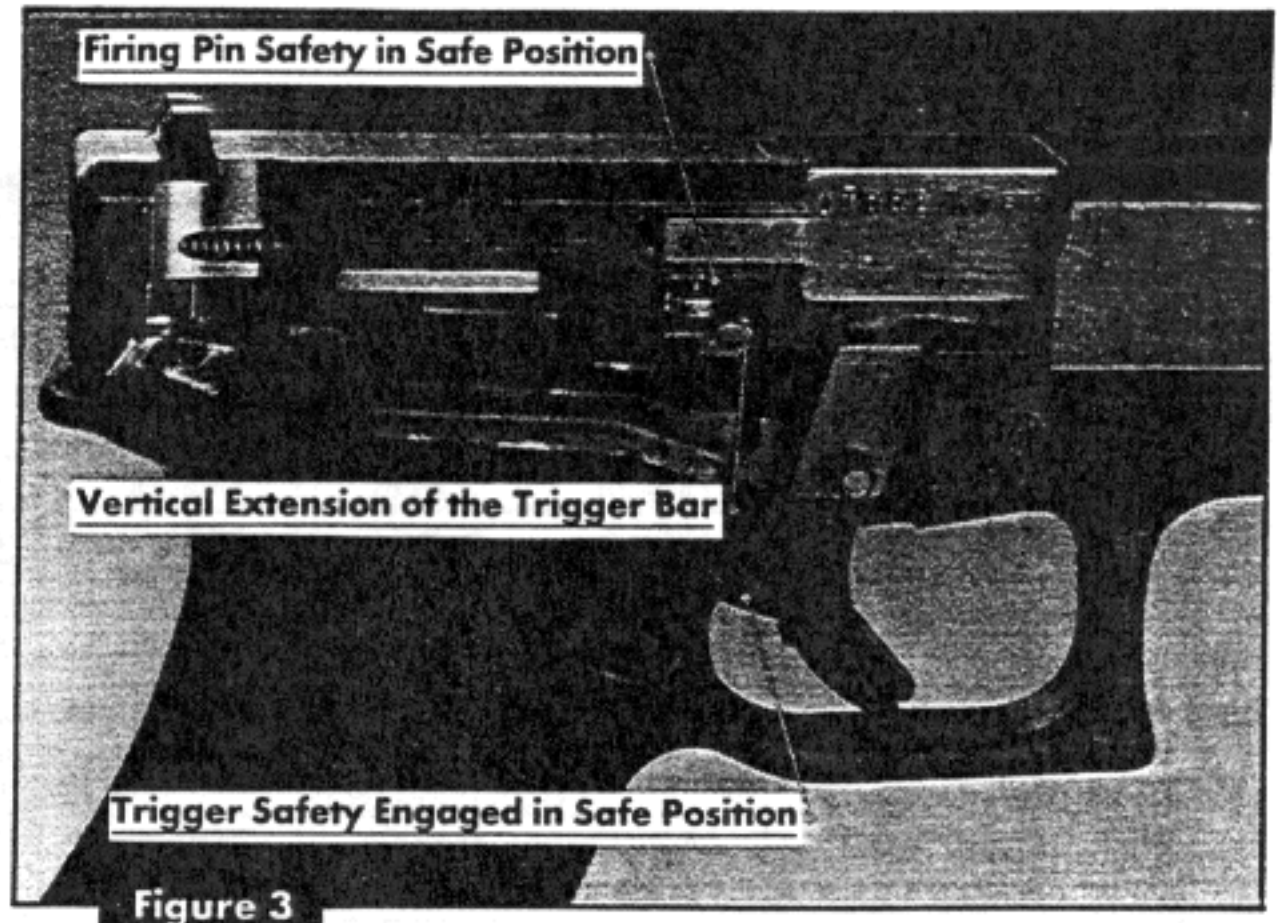

The trigger safety has been depressed allowing the trigger to move rearward. As the trigger moved rearward the vertical extension of the trigger bar has pushed the firing pin safety into the up (fire) position (Figure 4).

Read the owner's manual provided with your GLOCK pistol before removing your GLOCK pistol from its container.

Your new GLOCK pistol should be properly cleaned and lubricated before firing. Refer to Page 19 (Preventive Maintenance).

III. TECHNICAL DATA SPECIFICATIONS

	GLOCK 17		GLOCK 19		GLOCK 17L	
	Metric	U.S.	Metric	U.S.	Metric	U.S.
Type of Action	Safe Action (Double Action Only)		Safe Action (Double Action Only)		Safe Action (Double Action Only)	
Calibre	9 x 19 mm (Para)		9 x 19 mm (Para)		9 x 19 mm (Para)	
Overall Length (Slide)	185mm	7.28 in.	174mm	6.85 in.	225mm	8.85 in.
Height with Sights	136mm	5.35 in.	124mm	4.88 in.	136mm	5.35 in.
Width	30mm	1.18 in.	30mm	1.18 in.	30mm	1.18 in.
Length Between Sights	165mm	6.49 in.	152mm	5.98 in.	205mm	8.07 in.
Barrel length	114mm	4.49 in.	102mm	4.02 in.	153mm	6.02 in.
Barrel Rifling	hexagonal profile with right hand twist		hexagonal profile with right hand twist		hexagonal profile with right hand twist	
Length of Twist	250mm	9.84 in.	250mm	9.84 in.	250mm	9.84 in.
Magazine capacity	17/19	17/19	15/17	15/17	17/19	17/19
Mass (Weight)						
—Empty without magazine	620g	21.91 oz.	595g	20.99 oz.	666g	23.35 oz.
—Empty magazine	^(17 Rounds) 56g	2.08 oz.	^(15 Rounds) 54g	1.98 oz.	^(17 Rounds) 56g	2.08 oz.
—Full magazine*	^(17 Rounds) ~260g	~9.50 oz.	^(15 Rounds) ~240g	~8.55 oz.	^(17 Rounds) ~260g	~9.50 oz.
Muzzle Velocity*	~360 m/sec	~1180 fps	~360 m/sec	~1180 fps	~360 m/sec	~1180 fps
Muzzle Energy*	~500 J	~369 Ft. Lbs.	~500 J	~369 Ft. Lbs.	~500 J	~369 Ft. Lbs.
Trigger Pull	~2.5kg	~5-8 lbs.	~2.5kg	~5-8 lbs.	~2.5kg	~3.5 lbs.
Trigger Slack	10mm	0.4 in.	10mm	0.4 in.	10mm	0.4 in.
Trigger Travel For Discharge	12.5mm	0.5 in.	12.5mm	0.5 in.	12.5mm	0.5 in.
Number of Safeties	3	3	3	3	3	3

*Varies depending on type of ammunition.

Specifications subject to change without notice.

Notes: _____

GLOCK 20		GLOCK 21		GLOCK 22		GLOCK 23	
Metric	U.S.	Metric	U.S.	Metric	U.S.	Metric	U.S.
Safe Action (Double Action Only)		Safe Action (Double Action Only)		Safe Action (Double Action Only)		Safe Action (Double Action Only)	
10mm		.45 ACP		.40 S&W		.40 S&W	
193mm	7.59 in.	193mm	7.59 in.	185mm	7.28 in.	174mm	6.85 in.
139mm	5.47 in.	139mm	5.47 in.	136mm	5.35 in.	124mm	4.88 in.
32.5mm	1.27 in.	32.5mm	1.27 in.	30mm	1.18 in.	30mm	1.18 in.
172mm	6.77 in.	172mm	6.77 in.	165mm	6.49 in.	152mm	5.98 in.
117mm	4.60 in.	117mm	4.60 in.	114mm	4.49 in.	102mm	4.02 in.
hexagonal profile with right hand twist		octagonal profile with right hand twist		hexagonal profile with right hand twist		hexagonal profile with right hand twist	
400mm	15.75 in.	400mm	15.75 in.	400mm	15.75 in.	400mm	15.75 in.
15	15	13	13	15	15	13	13
784g (15 Rounds)	26.35 oz.	745g (13 Rounds)	25.22 oz.	645g (15 Rounds)	22.36 oz.	597g (13 Rounds)	20.67 oz.
65g (15 Rounds)	2.05 oz.	65g (13 Rounds)	1.98 oz.	53g (15 Rounds)	1.87 oz.	52g (13 Rounds)	1.76 oz.
~325g	~11.92 oz.	~340g	~11.78 oz.	~300g	~10.62 oz.	~260g	9.35 oz.
~370 m/sec	~1230 fps	~250 m/sec	~ 820 fps	~300 m/sec	~ 984 fps	~300 m/sec	~ 984 fps
~750 J	~575 Ft. Lbs.	~460 J	~302 Ft. Lbs.	~520 J	~386 Ft. Lbs.	~520 J	~386 Ft. Lbs.
~2.5kg	~5-8 lbs.	~2.5kg	~5-8 lbs.	~2.5kg	~5-8 lbs.	~2.5kg	~5-8 lbs.
10mm	0.4 in.	10mm	0.4 in.	10mm	0.4 in.	10mm	0.4 in.
12.5mm	0.5 in.	12.5mm	0.5 in.	12.5mm	0.5 in.	12.5mm	0.5 in.
3	3	3	3	3	3	3	3

*Varies depending on type of ammunition.

Specifications subject to change without notice.

Notes:

IV. AMMUNITION SPECIFICATIONS FOR GLOCK PISTOL

GLOCK pistols are designed to be fired with NATO specification ammunition. Therefore the following guidelines and specifications are provided so that proper ammunition will be selected for use in GLOCK pistols to assure proper functioning. Any deviation from these specifications may lead to improper functioning and possibly void the warranty on GLOCK pistols. (GLOCK pistols will function properly with the new generation of 9x19mm ammunition including all +p+ and 147 grain sub-sonic ammunition currently being introduced in the United States.)

Minimum (lower limit) specifications for ammunition to be used in Glock pistols:

Bullet Weight
115 grains/7.5 grams

Velocity
1180 fps/350m/sec

Maximum (upper limit) pressures for 9 x 19mm ammunition to be used in Glock pistols should not exceed 43,500 pounds per square inch/3000 BAR

Handloaded/reloaded or re-manufactured ammunition may be unsafe and voids factory warranty.

AMMUNITION PERFORMANCE DATA

(Compiled by Glock, Inc.)

CARTRIDGE	MANUFACTURER	BULLET WEIGHT	BULLET TYPE	BARREL LENGTH	VELOCITY	KINETIC ENERGY	PENETRATION	EXPANSION
9MM (FBI)	Winchester	147 gr/9.53 grm	JHP	4.25 in/107.9 mm	902 fps/275 m/sec	265.5 ft./lb./360J	13.99 in./355.3 mm	.457 in/11.6 mm
9MM	Winchester	115 gr/7.45 grm	STIP	4.25 in/107.9 mm	1091 fps/333 m/sec	303.9 ft./lb./412J	11.37 in/288.8 mm	.542 in/13.7 mm
9MM	Federal	147 gr/9.53 grm	HSHOK	4.25 in/107.9 mm	1062 fps/324 m/sec	310.5 ft./lb./421J	14.67 in/372.6 mm	.485 in/12.3 mm
9MM (+ P +)	Winchester	115 gr/7.45 grm	JHP	4 in/101.6 mm	1305 fps/398 m/sec	437 ft./lb./593J	approx. 8.0 in/203 mm	.600 in/15.2 mm
9MM (NATO)	Winchester	124 gr/8.04 grm	FMJ	4 in/101.6 mm	1185 fps/361 m/sec	387 ft./lb./525J	N/A	N/A
9MM	Remington	88 gr/5.70 grm	JHP	4 in/101.6 mm	1500 fps/457 m/sec	440 ft. lb./597J	N/A	N/A
.40 CAL	Winchester	180 gr/11.66 grm	JHP	4 in/101.6 mm	990 fps/302 m/sec	390 ft./lb./529J	12.20 in/309.8 mm	.650 in/16.5 mm
.40 CAL	Federal	180 gr/11.66 grm	HSHOK	4 in/101.6 mm	985 fps/300 m/sec	384 ft./lb./520J	14.00 in/355.6 mm	.690 in/17.5 mm
.40 CAL	Winchester	155 gr/10.04 grm	STIP	4 in/101.6 mm	1205 fps/367 m/sec	500 ft./lb./678J	12.70 in/322.6 mm	.600 in/15.2 mm
.40 CAL	Federal	180 gr/11.66 grm	JHP	4 in/101.6 mm	985 fps/300 m/sec	390 ft./lb./529J	N/A	N/A
10MM (FBI)	Federal	180 gr/11.66 grm	JHP	5 in/127 mm	931 fps/284 m/sec	346.4 ft./lb./470J	17.24 in/437.8 mm	.547 in/13.9 mm
10MM	Winchester	180 gr/11.66 grm	JHP	5 in/127 mm	955 fps/291 m/sec	364.5 ft./lb./494J	16.61 in/421.8 mm	.526 in/13.4 mm
10MM	Norma	170 gr/11.02 grm	JHP	5 in/127 mm	1358 fps/414 m/sec	696.1 ft./lb./944J	18.44 in/468.4 mm	.562 in/14.3 mm
10MM	Homaday	155 gr/10.04 grm	JHP	N/A	1410 fps/430 m/sec	692 ft./lb./938J	N/A	N/A
10MM	Homaday	200 gr/12.96 grm	FMJ	N/A	1150 fps/351 m/sec	595 ft./lb./807J	N/A	N/A
.45 ACP	Remington	185 gr/11.99 grm	JHP	5 in/127 mm	903 fps/275 m/sec	334.9 ft./lb./454J	22.21 in/564.1 mm	.540 in/13.7 mm
.45 ACP	Federal	185 gr/11.99 grm	JHP	5 in/127 mm	953 fps/291 m/sec	373 ft./lb./506J	13.62 in/345.9 mm	.623 in/15.8 mm
.45 ACP	Winchester	185 gr/11.99 grm	STIP	5 in/127 mm	951 fps/290 m/sec	371.5 ft./lb./504J	13.58 in/344.9mm	.619 in/15.7 mm
.45 ACP	Federal	230 gr/14.90 grm	HSHOK	5 in/127 mm	802 fps/244 m/sec	328.5 ft./lb./445J	18.28 in/464.3 mm	.621 in/15.8 mm
.45 ACP + P	Remington	185 gr/11.99 grm	JHP	N/A	1140 fps/347 m/sec	534 ft./lb./724J	N/A	N/A

NOTE: Performance levels may change when using different firearms.

Source: Cartridge Manufacturers and FBI

V. FIELD STRIPPING

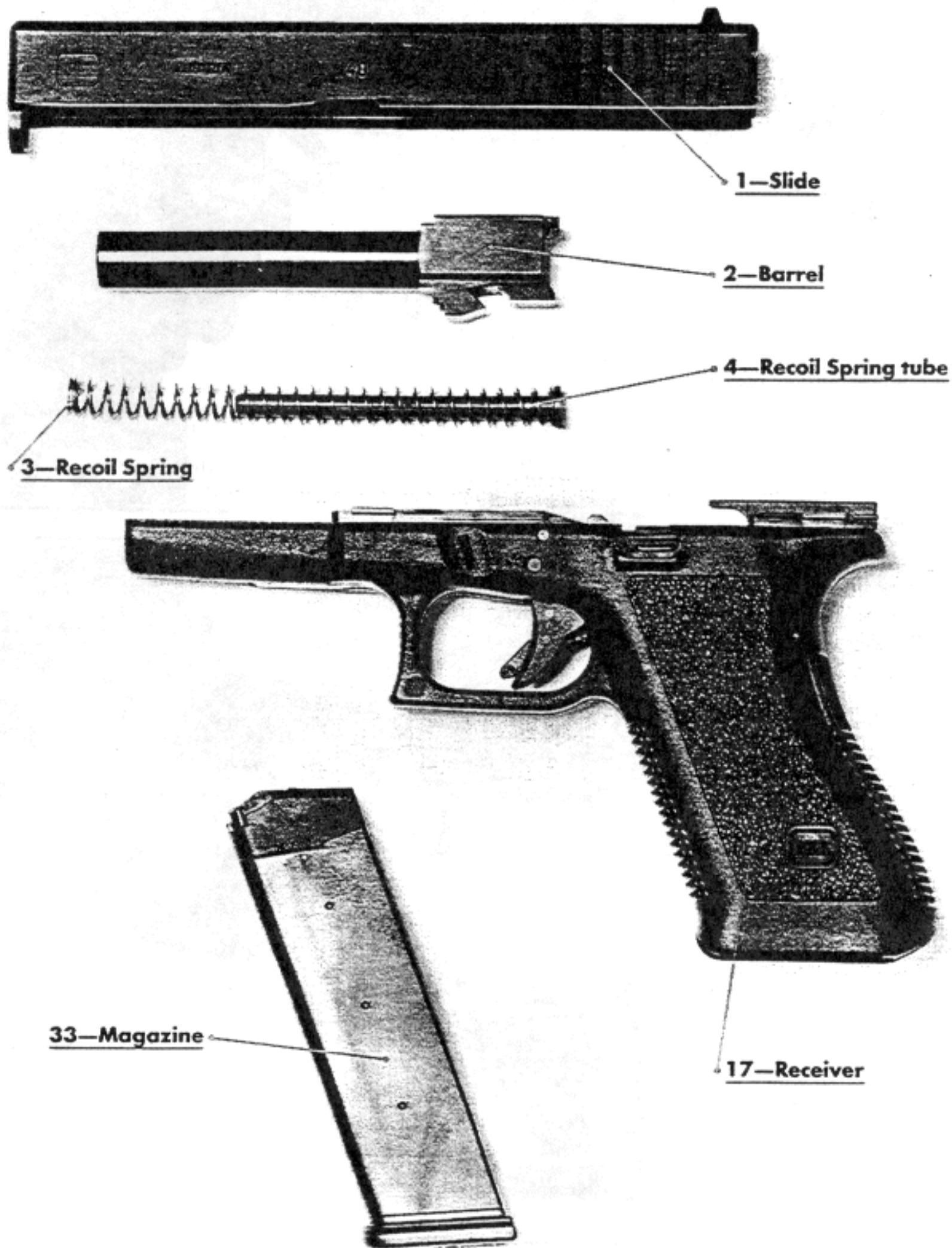

Figure 5

PRIOR TO FIELD STRIPPING, MAKE SURE PISTOL IS UNLOADED

Magazine Removal

- POINT the pistol in a safe direction (a safe direction is where no one can possibly be injured in the event of an accidental discharge)—Finger OFF of trigger and OUT of the trigger guard.
- PRESS in on the magazine catch (Figure 6).
- Remove the magazine.

Note:

The GLOCK pistol is designed so that the magazine catch can not easily be pressed unintentionally when the pistol is held in a proper shooting grip. For this reason you will have to rotate the hand a few degrees to be able to press the catch and release the magazine.

Safety Caution:

Prior to further disassembly; with your finger off of the trigger and outside of the trigger guard, point the pistol in a safe direction, lock the slide open by pushing up on the slide stop lever while pulling the slide to the rear with the non-shooting hand (Figure 7). Once the slide is locked to the rear, both visually and physically (with your little finger) inspect the chamber of the pistol to be sure that the chamber is empty (Figure 8). Also, check the magazine well to be sure that a cartridge has not become lodged between the ejector and the walls of the magazine well. Once you are sure that the pistol is unloaded continue with disassembly.

Once you have verified that the pistol is unloaded:

- Pull back slide to release slide stop lever and close action.
- POINT the pistol in a Safe Direction then PULL the trigger. You will hear the firing pin spring forward.



Figure 6



Figure 7

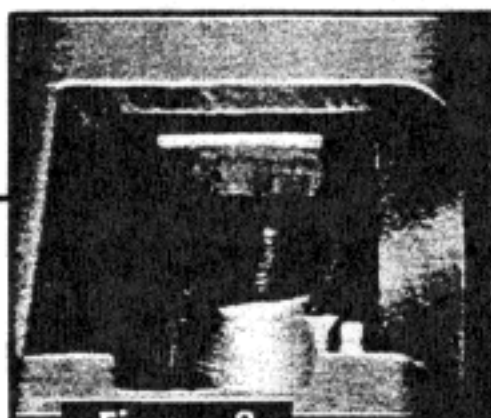

Figure 8

Note:

The trigger must be in the rearmost position for slide removal.

Slide Removal

- HOLD the pistol in either hand so that four fingers grasp the top of the slide as shown (Figure 9). With these four fingers, pull and hold the slide back approximately 1/10 inch (2.5mm).

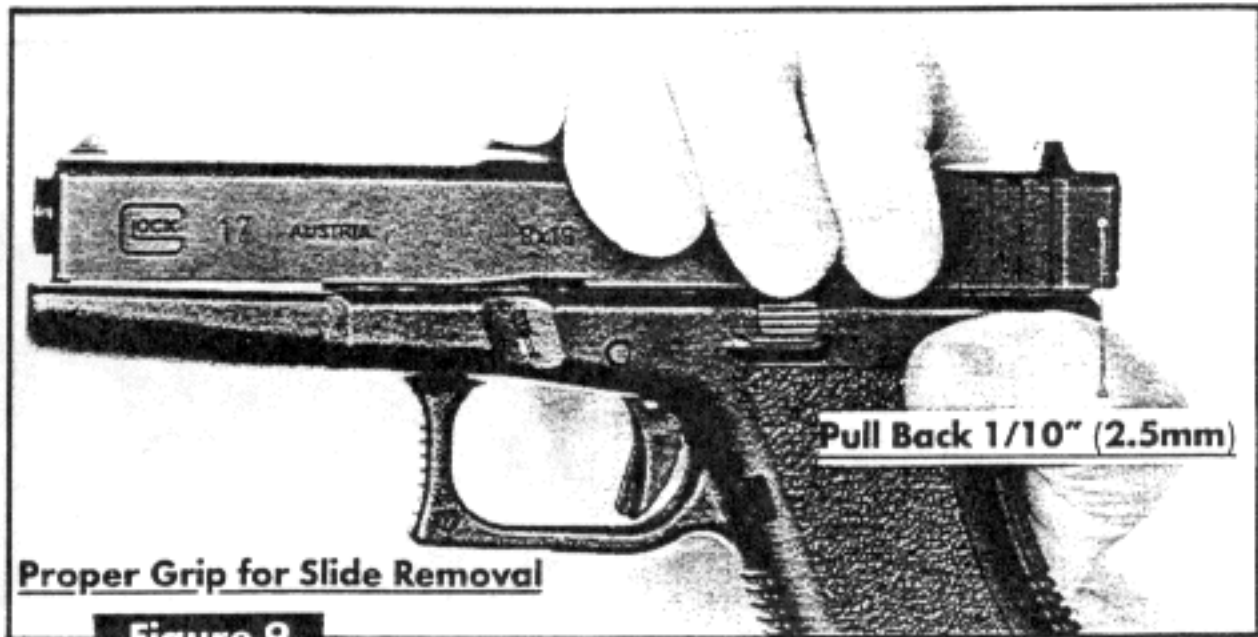

Figure 9

- Simultaneously, pull down and hold both sides of the slide lock using the thumb and index finger of your free hand (Figure 10).

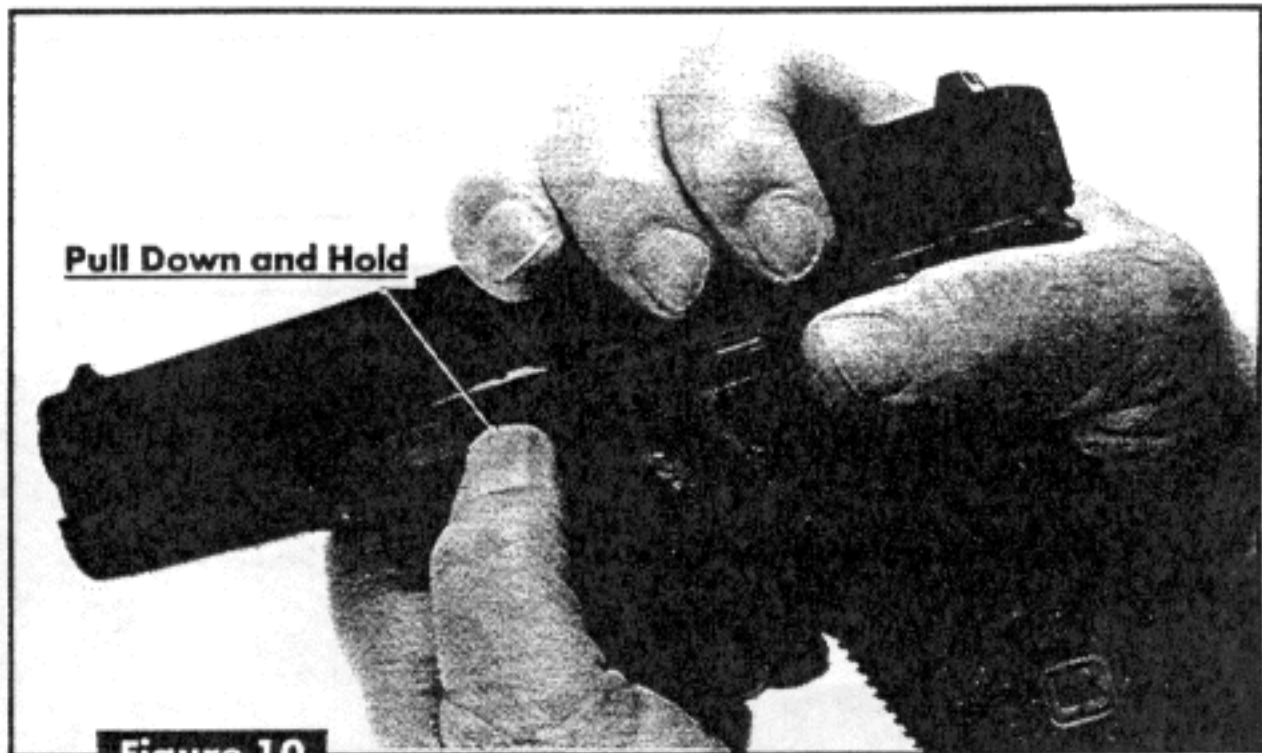

Figure 10

Notes:

- PUSH the slide forward until it is fully separated from the receiver (Figure 11).

Figure 11



Note:

With the slide and receiver separated, the operation of the trigger safety can be checked. See section VI, Function Testing the Trigger Safety prior to operating the trigger with slide removed.

Barrel Removal

Safety Caution:

The recoil spring is under tension. During removal use care to control the recoil spring and/or recoil spring tube.

- PUSH the recoil spring tube slightly forward while lifting it away from the barrel (Figure 12).
- REMOVE the recoil spring tube and recoil spring (Figure 13).

Figure 12



Figure 13

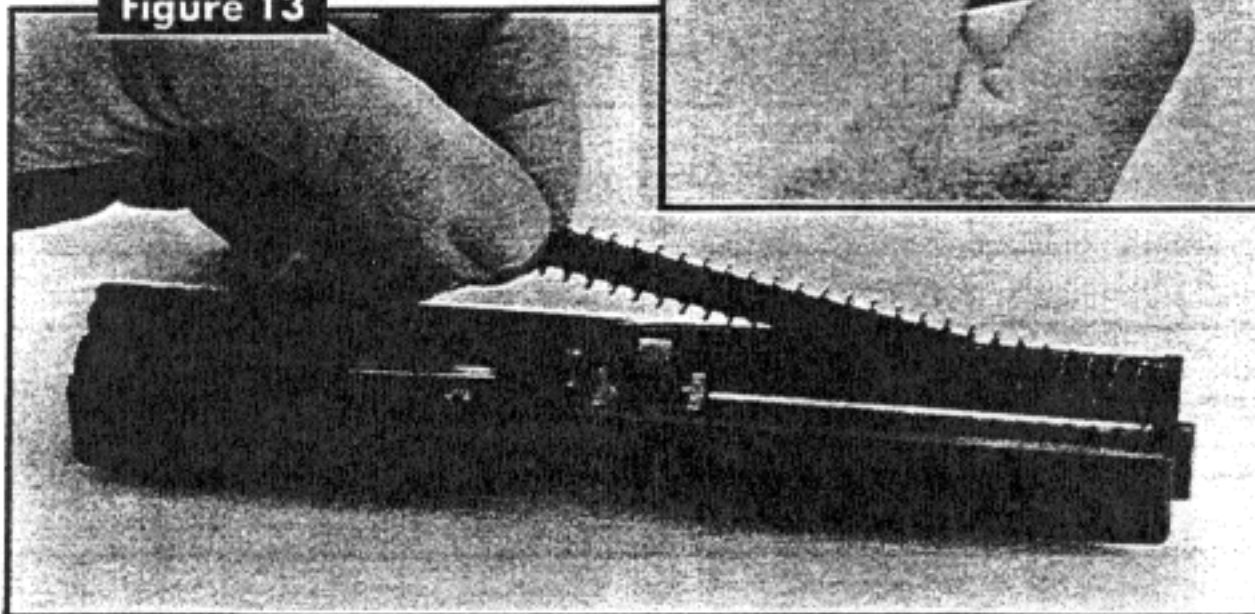

Figure 13a



*RECOIL SPRING ASSEMBLY
(Modification introduced in 1991)

*Note: Do not disassemble.

Notes:

Reassembly Note:

When installing the recoil spring tube and recoil spring, be sure that the back end of the recoil spring tube rests in the half moon cut in the bottom of the front barrel lug (Figure 14).

- Grasp the barrel at the chamber. While raising the chambered end, move the barrel slightly forward (Figure 15). Then lift the barrel from the slide.



Figure 14

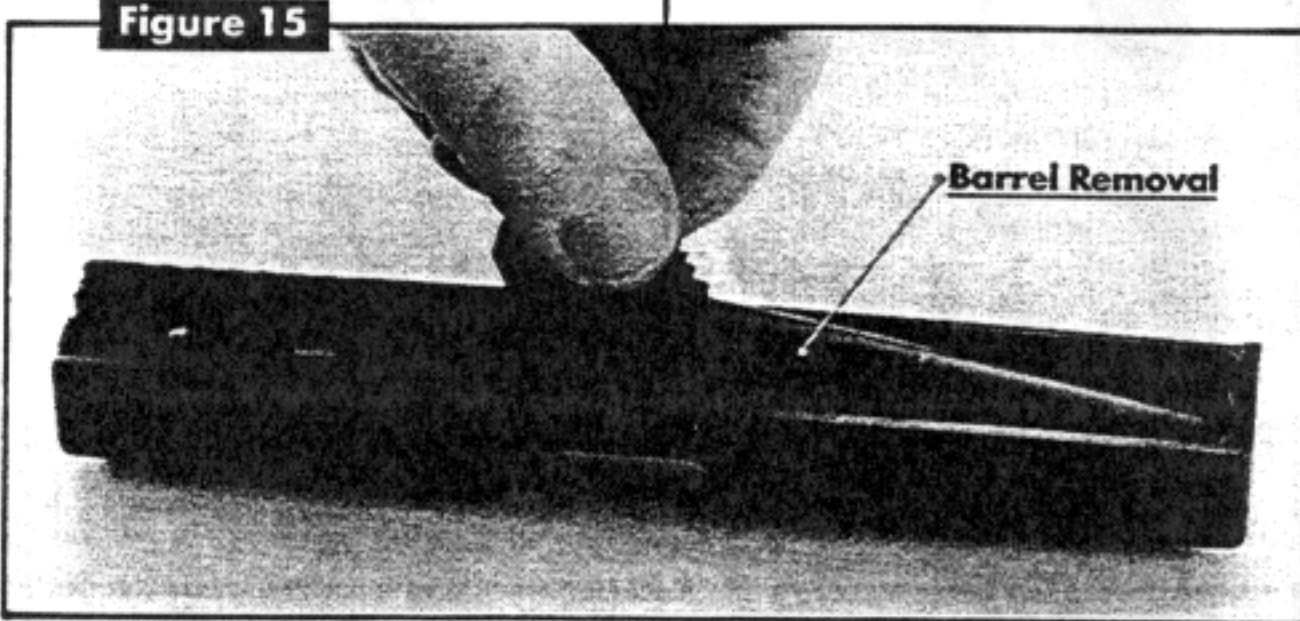

Figure 15

Notes:

Magazine Disassembly

For all standard floorplates, hold the magazine as shown. Press inward with the thumb and first finger as you push the magazine floorplate forward (Figure 16). As soon as the floorplate starts to move, reposition hand so thumb retains magazine spring. Remove the floor plate, the magazine spring and the follower.

(CAUTION: *The magazine spring is under tension. Be sure to maintain downward pressure on magazine spring with your thumb while disassembling.*

The pistol is now field stripped. Further disassembly is not required for normal cleaning and maintenance.



Figure 16

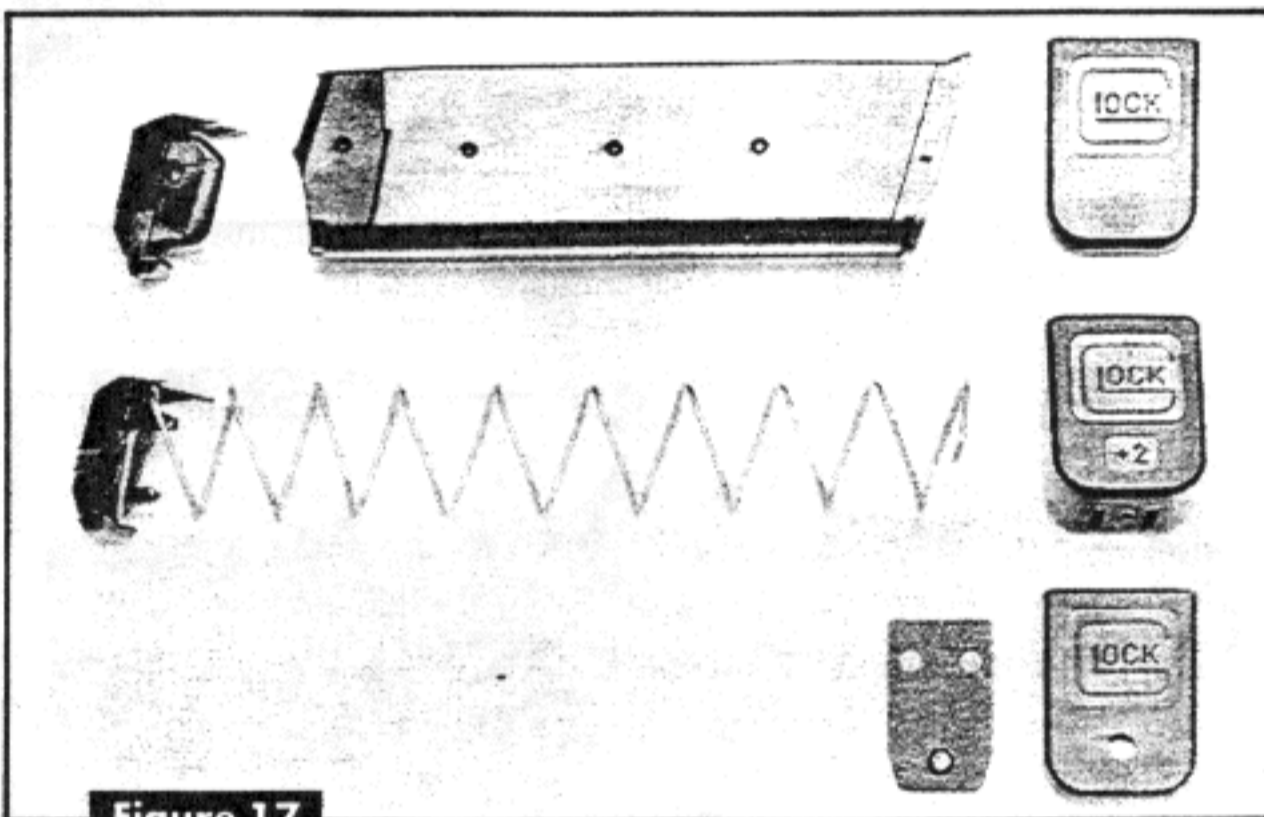

Figure 17

To remove the floor plate with the magazine reinforcement plate, insert punch into indentation in floor plate, push reinforcement plate inside magazine tube, then remove floor plate the same way as the standard floor plate. (Figure 18).

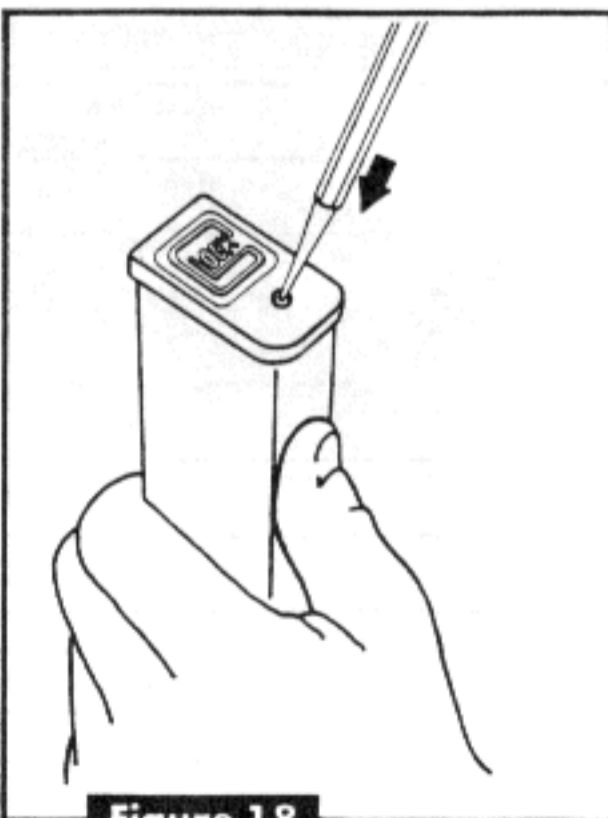

Figure 18

Notes: _____

VI. PREVENTATIVE MAINTENANCE

Note:

Refer to page 13 for proper method of field stripping the pistol.

Cleaning the Field Stripped Firearm

The GLOCK pistol requires periodic cleaning to insure proper function. Once field stripped, the barrel and chamber are easily cleaned from the chamber end. The inside of the slide and receiver should be wiped clean. Standard firearm solvents can be used on the pistol. This will insure proper functioning of a new GLOCK pistol.

The copper colored lubricant that is found on portions of the slide should not be removed as it will assure long-term lubrication of the slide.

As with any semiautomatic pistol, GLOCK pistols should not be cleaned by merely locking the slide to the rear and inserting the cleaning rod from the muzzle end. This can cause excessive amounts of solvents to build up in both the frame and

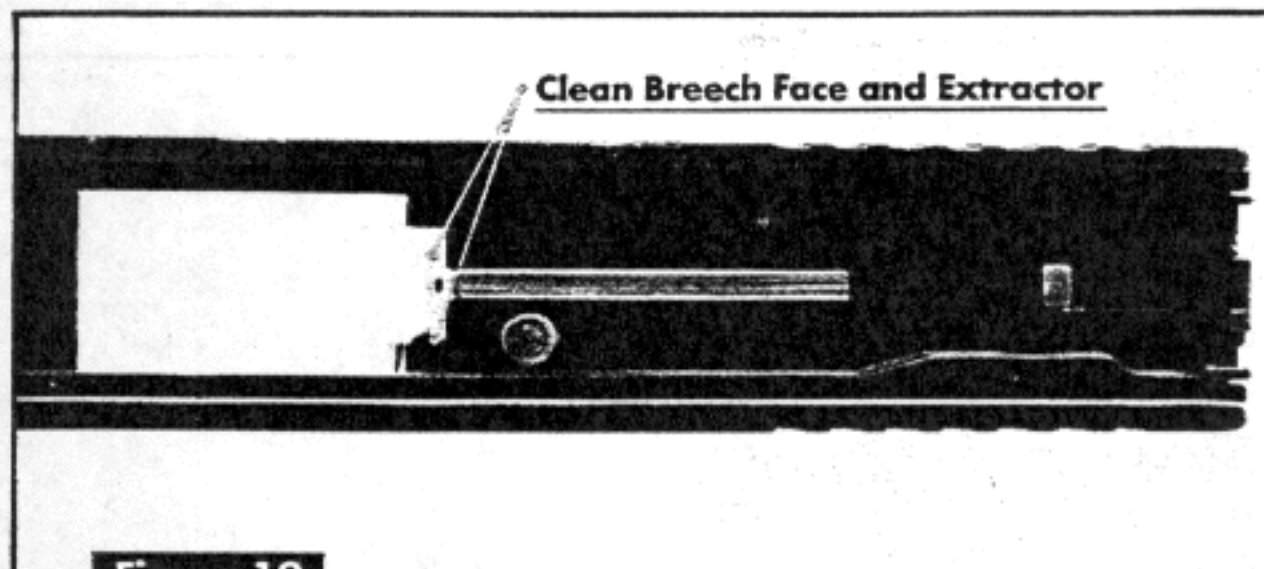

Figure 19

slide, and possibly contribute to malfunctions of the pistol. The pistol should be field-stripped every time it is cleaned.

The inside of both the chamber and barrel should be wiped completely dry once they have been thoroughly cleaned. The breech face and the area under the extractor claw should both be absolutely dry and free of any debris after cleaning.

The slide rail cuts should be cleaned thoroughly by using a clean patch on the end of a toothbrush-type cleaning tool.

With the clean patch wrapped

over the brush portion of the toothbrush, thoroughly clean the slide rail cuts of all debris and solvents.

All other areas of the slide and frame should be checked for cleanliness. Most parts in the frame may be wiped with a clean, soft cloth that has been *slightly* dampened with a quality firearm cleaning solvent.

After the parts in the frame have been cleaned, they should be wiped dry with a clean, soft cloth. All solvent should be wiped from the parts so that they are clean and dry.

Notes:

Lubricating The Field Stripped Firearm

To properly lubricate your GLOCK pistol after it has been thoroughly cleaned and dried, use a clean patch that has been slightly dampened with quality gun oil. Wipe the barrel; the barrel hood; the inside of the slide where the barrel hood rubs against the slide; and the ring that the barrel slides through the slide. You can take one drop of oil on your finger and rub each slide rail, or put one drop of oil in each slide rail cut. Once the slide is moved on the receiver after reassembly, the oil drop will be distributed equally in the slide rails by moving the slide. Most important is the drop of oil (Figure 20) where connector & trigger bar meet.

This will assure proper lubrication of your GLOCK pistol without over-lubricating. GLOCK pistols are designed to operate properly with only small amounts of lubrication.

Do not over-lubricate your GLOCK pistol, as large quantities of oil or grease will collect unburnt powder and other residue, which could interfere with proper functioning of your GLOCK pistol.

Dry Firing

Do not pull back lug of firing pin and let snap forward when

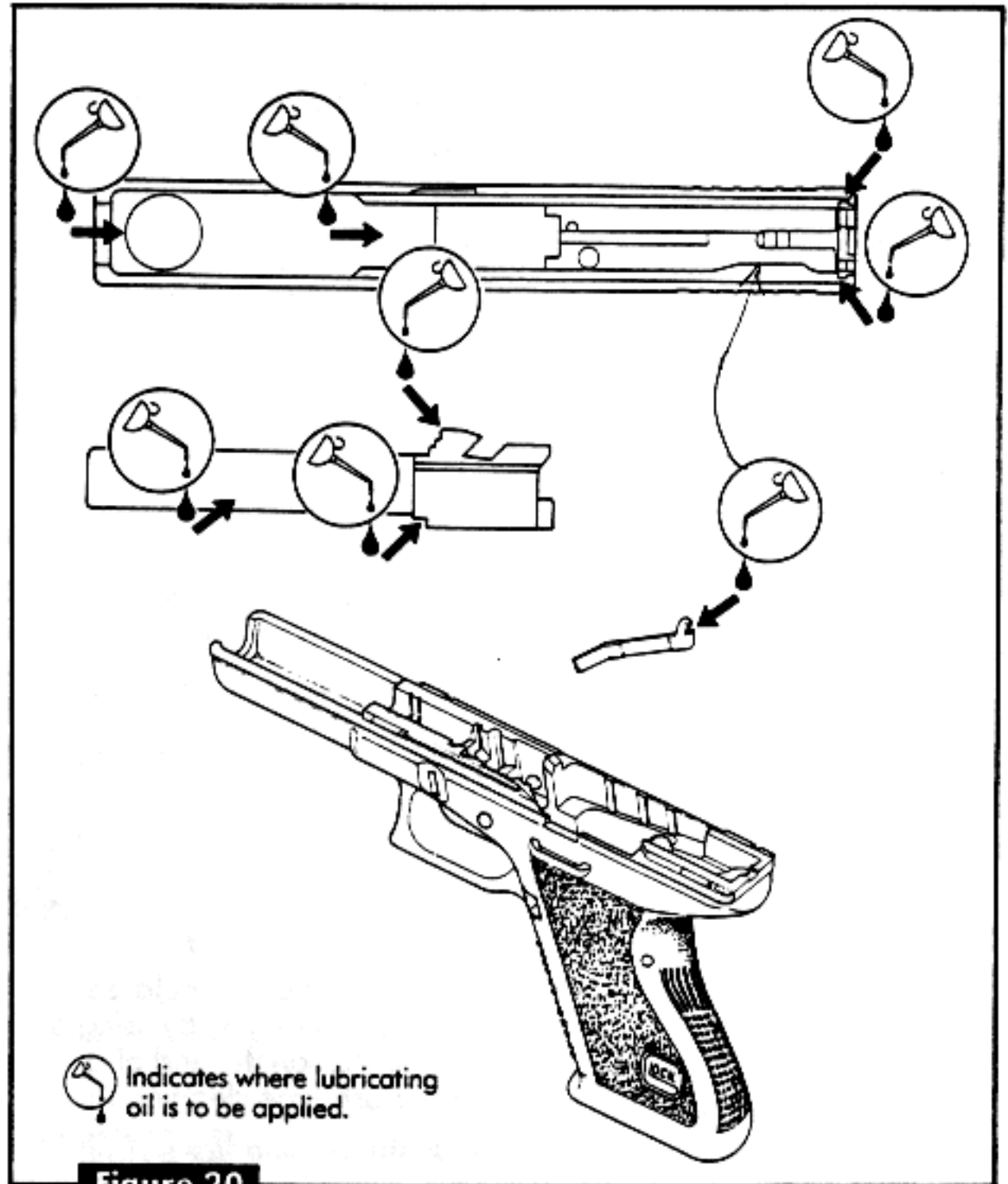

slide is removed from frame, as damage to the firing pin and firing pin safety could result.

WARNING:

Do not put oil inside firing pin channel or magazine tube. Firing pin channel, magazine

tube and breech face should be wiped dry before reassembly. Leaving solvent or lubricant in these areas could cause contamination of primers and failure to fire.

Notes:

Function Testing the Trigger Safety

Once the slide is removed from the receiver the trigger safety can be function-tested in the following manner. Push forward on the vertical extension of the trigger bar as shown (Figure 21). The trigger will move forward and the trigger safety should engage, holding the trigger in a semi-forward position even if you release pressure on the trigger bar. This verifies the proper engagement of the trigger safety.

(Do not pull trigger after slide is removed, as the trigger safety is resting against the rear of the frame and the trigger safety may be damaged by doing so. Also, do not pull the trigger when the slide is locked to the rear on the pistol, as this could also damage the trigger safety.)

Then exert and maintain additional forward pressure on the vertical extension of the trigger bar until the trigger moves to its most forward position. While in this full forward position you can press the trigger. The trigger safety should disengage. Gradually release forward pressure on the trigger bar. As you do, the trigger should return to its rearward position.

This verifies the proper disengagement of the trigger safety.

Function Testing the Firing Pin Safety

Hold the slide in a **muzzle down** position and depress the firing pin safety. The tip of the firing pin should move forward and be visible protruding from the firing pin hole. The firing pin may need to be pushed forward when the pistol is new so that it will protrude from the

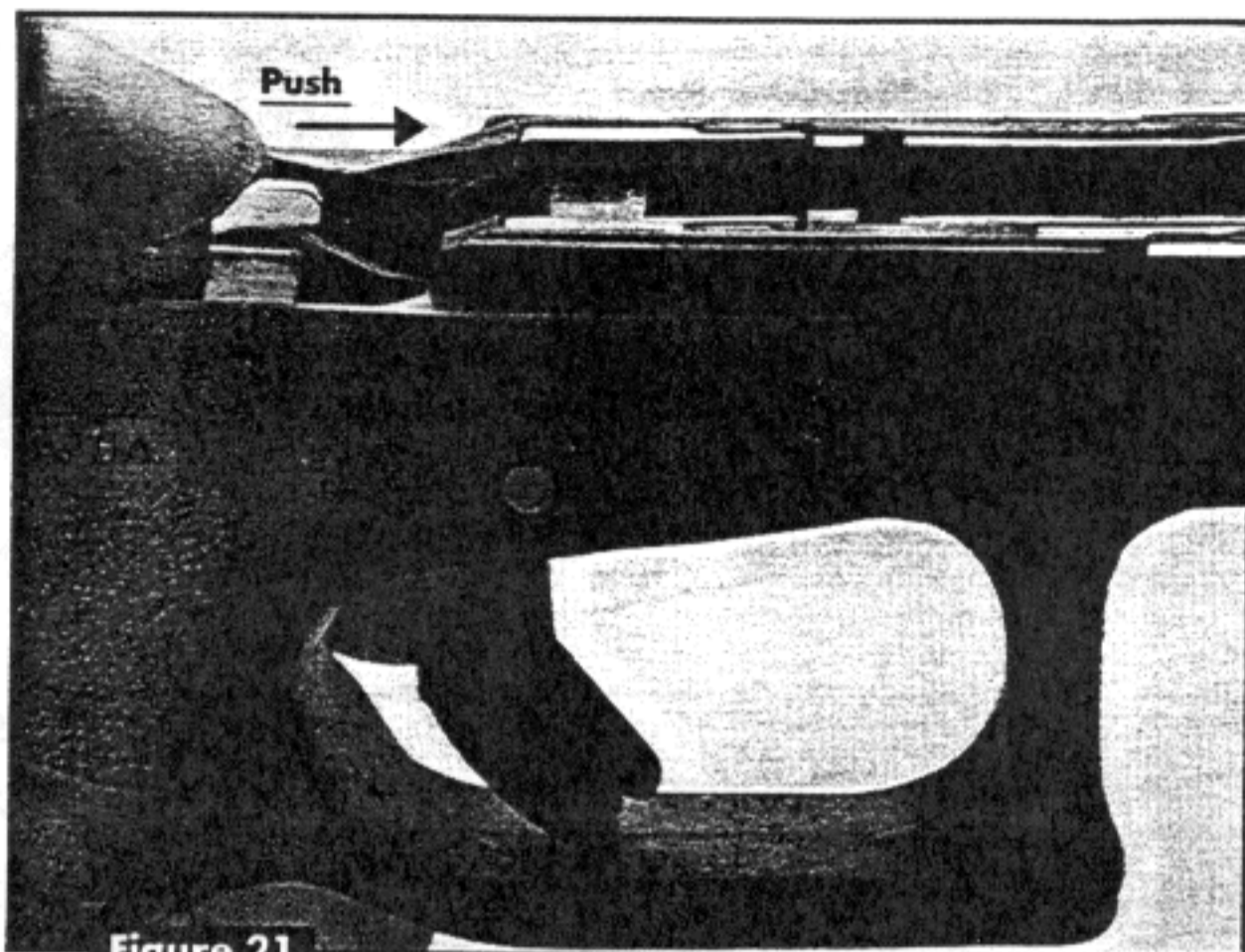

Figure 21

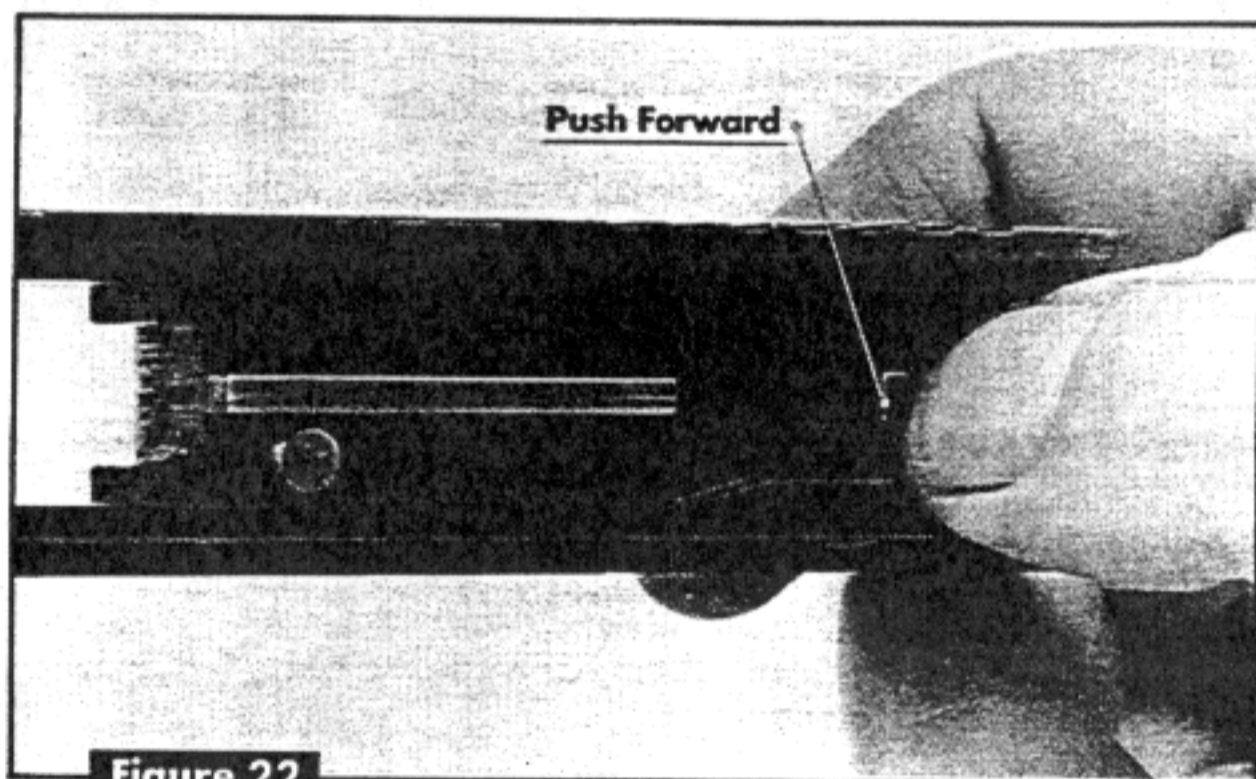

Figure 22

firing pin hole.

A second method of checking the proper movement of the firing pin is to depress the firing pin safety and shake the slide. When the firing pin safety is depressed the firing pin should be heard moving freely. When the firing pin safety is not depressed the firing pin should be nearly silent.

Next, making sure that the firing pin safety is properly engaged, hold the slide as shown and push forward on the rear end of the firing pin with your thumb (Figure 22). The firing pin should not protrude from the firing pin hole. If it does, the firing pin and firing pin safety should be replaced.

VII. SLIDE DISASSEMBLY

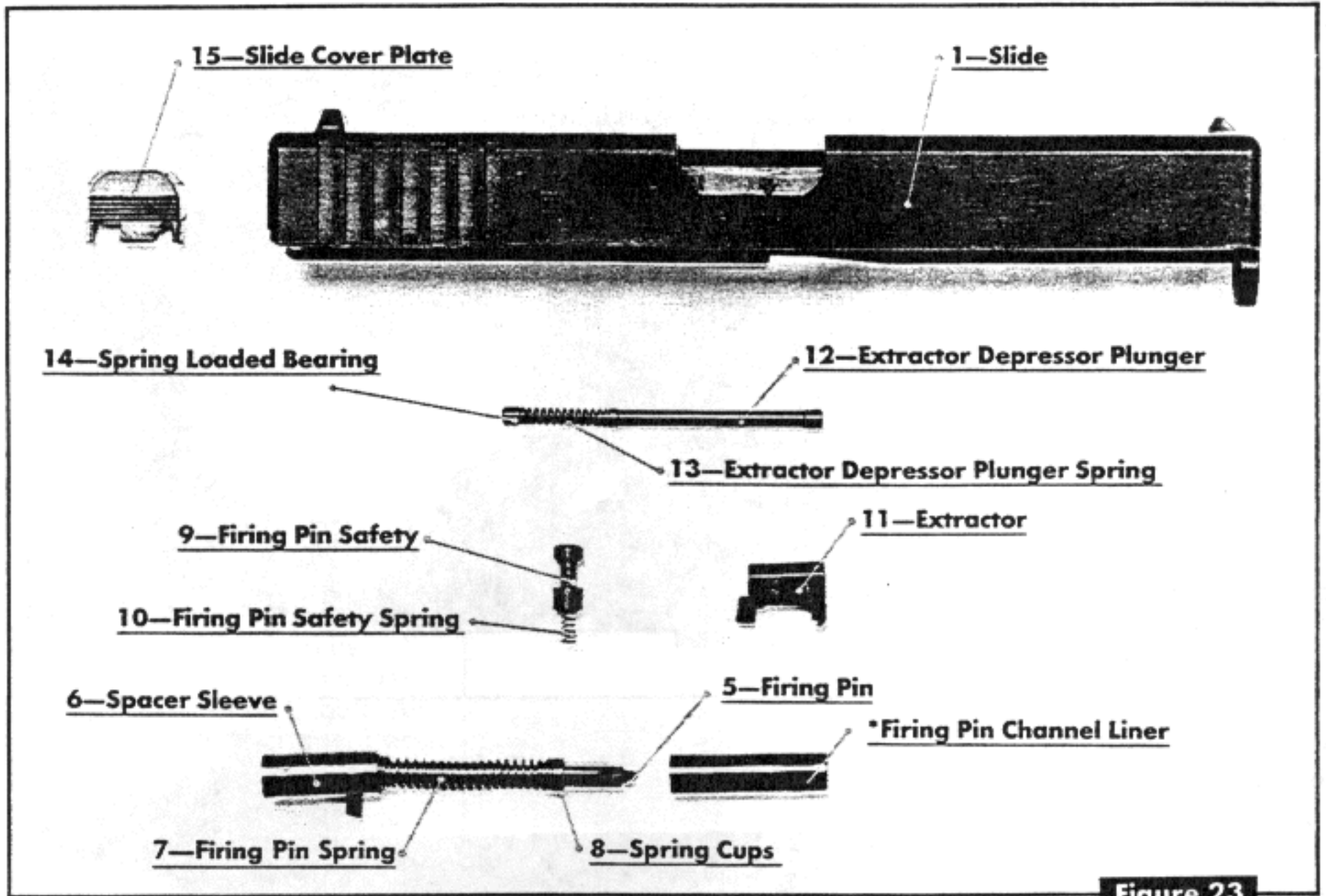

Figure 23

Only 3 tools are required for maintenance of the GLOCK pistol:

- | | | |
|---|--|--|
| 1. A Pin Punch 3/32" (2.5mm)
Such as: Sears Craftsman
42882WF | 2. A Screwdriver 1/8" Blade (3mm)
Such as: Sears Craftsman
41589WF | 3. Long Nose Pliers
Any common type |
|---|--|--|

*The Firing Pin Channel Liner is located inside the Firing Pin Channel and may separate occasionally when cleaning.

Notes:

Firing Pin Assembly Removal

Safety Caution:

The firing pin assembly and extractor depressor plunger are under tension. While removing the slide cover plate, place your thumb over the firing pin assembly and extractor depressor plunger to prevent these parts from ejecting while removing the slide cover plate.

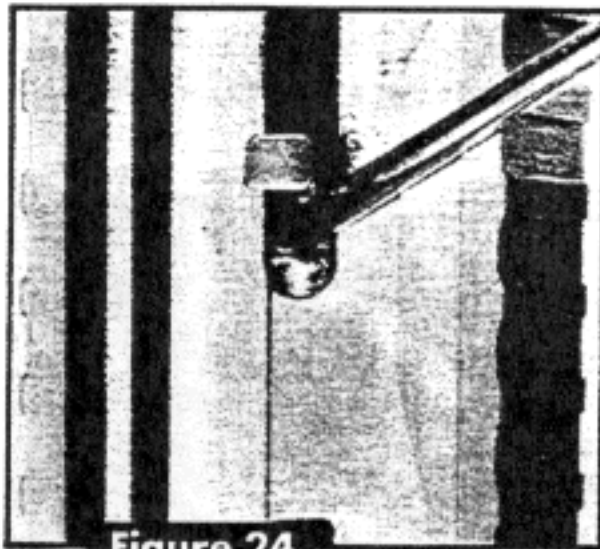

Figure 24

- To aid in the removal of the slide cover plate, place the muzzle end of the slide on a smooth, flat surface such as a table. Keep the slide in an upright position while applying firm downward pressure on the slide. With your free hand use a pin punch to push the spacer sleeve forward (Figures 24 & 25).
- Simultaneously, slide the cover plate down, and off—remember to keep the tensioned firing pin assembly and extractor depressor plunger from springing out.



Figure 25

It is possible that the slide cover plate will require some additional downward force during disassembly of a new pistol. A thin-bladed screwdriver may be used to start removal.

- REMOVE the firing pin assembly (Figure 26).
- REMOVE the extractor depressor plunger assembly consisting of: the extractor depressor plunger, extractor depressor plunger spring and the spring loaded bearing (Figure 27).



Figure 26

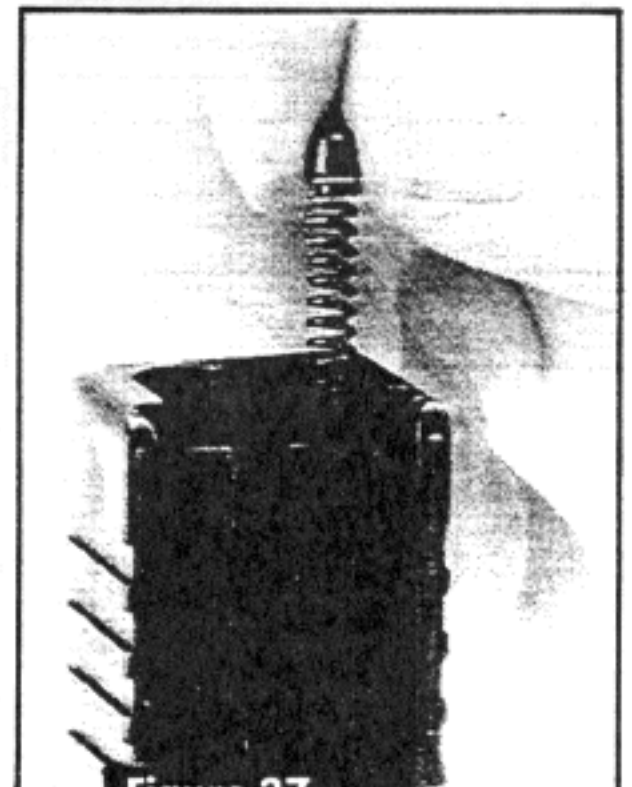
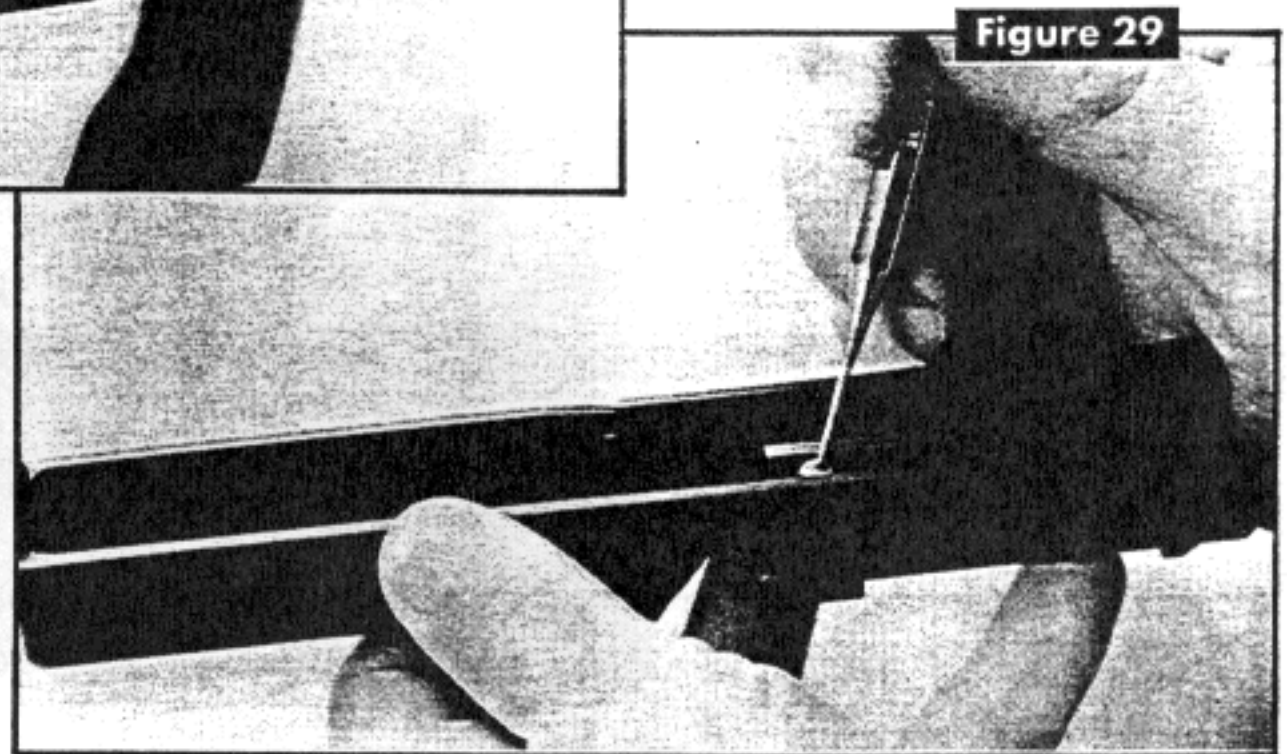

Figure 27

Extractor Removal



- While **DEPRESSING** the firing pin safety remove the extractor (Figure 28-30). (The extractor may need to be pushed from the extractor groove by using a pin punch in the rear of the extractor groove and lifting the extractor from the groove.)



Notes: _____



Firing Pin Assembly— Disassembly:

Note:

The slide may be used for disassembly & reassembly.

- Wipe the firing pin spring with a clean dry cloth to remove any excess lubrication or solvent. Then pull down on the firing pin spring with thumb & forefinger as far as possible to allow clearance for removal of the firing pin spring cups. (Be sure to keep a firm grasp on the firing pin spring so that it does not fly off the firing pin causing possible injury.)

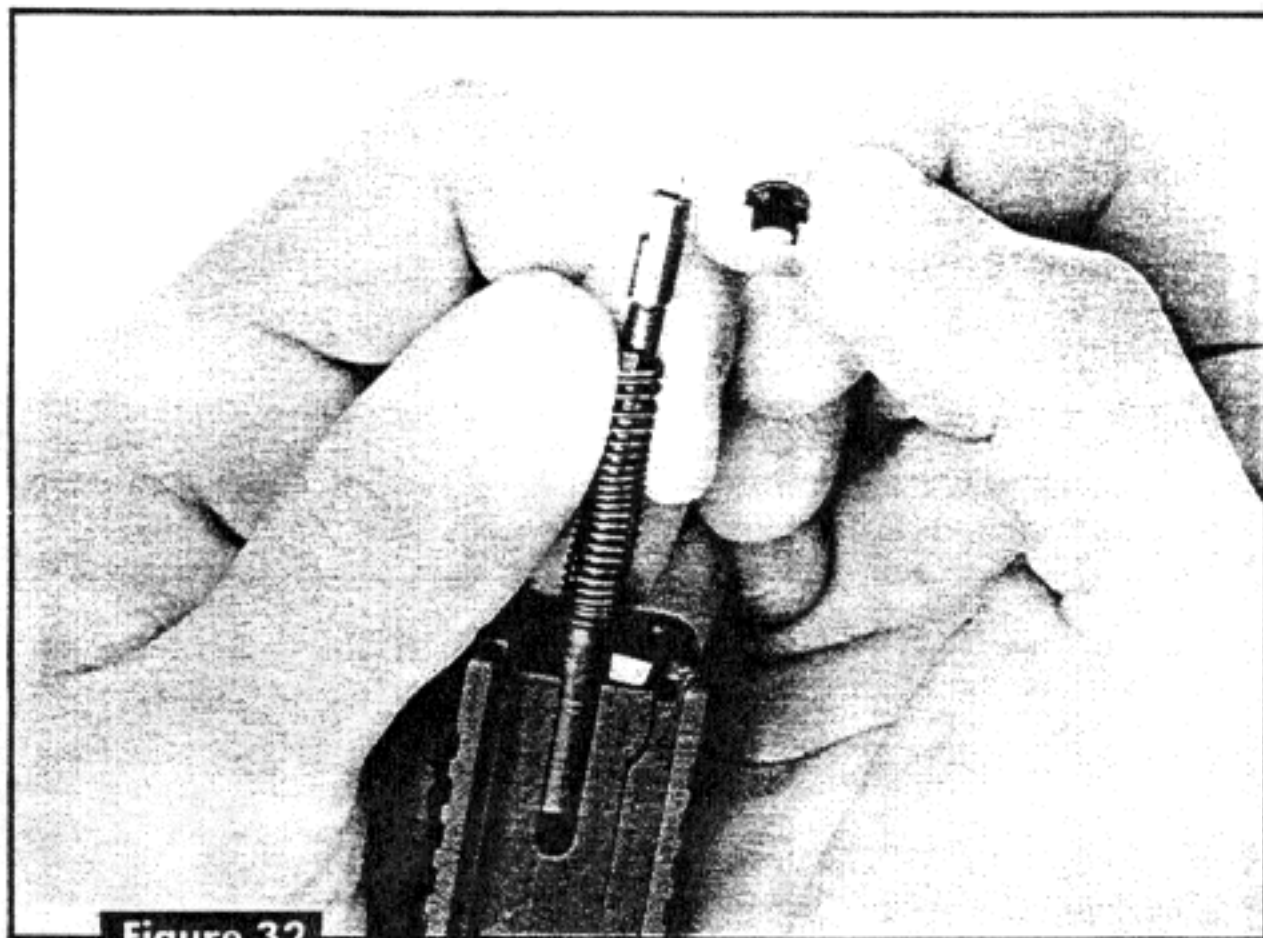
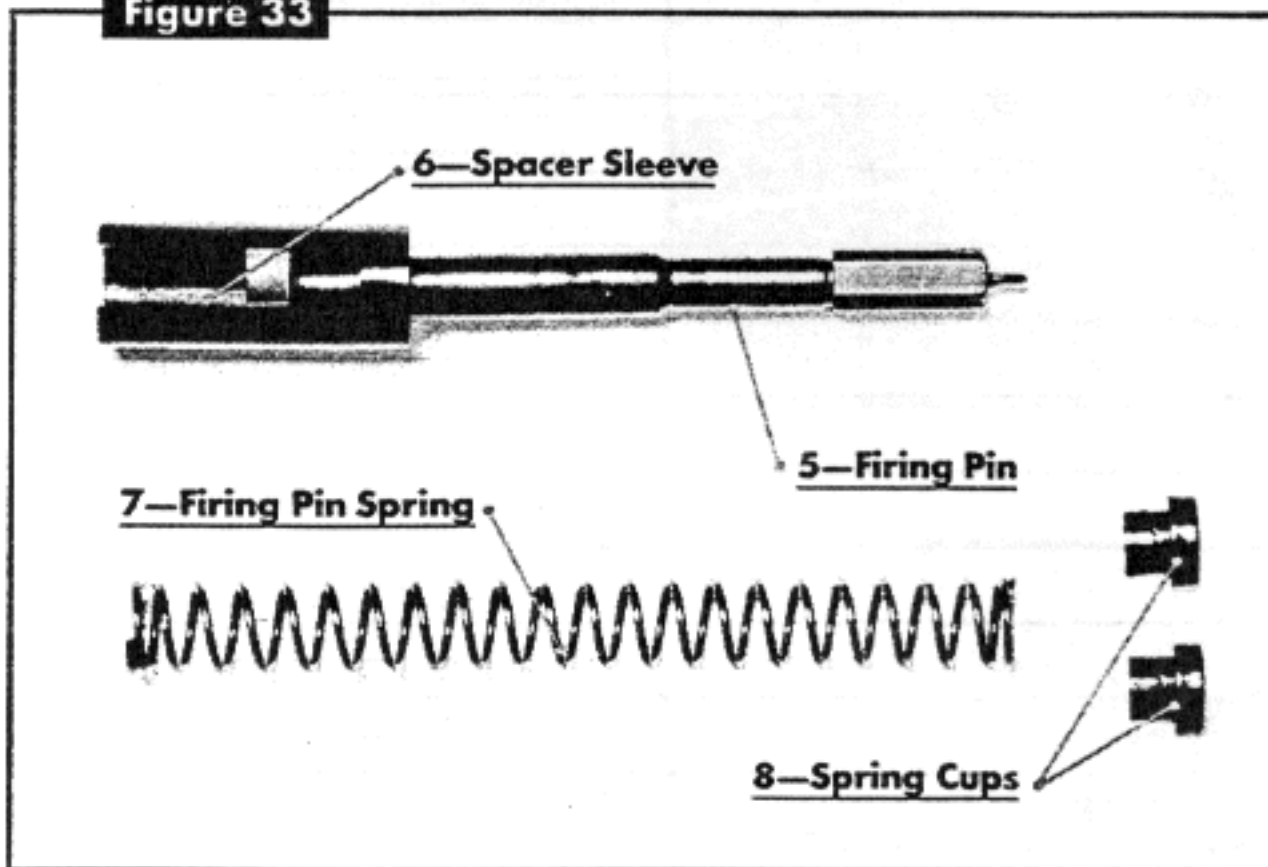

Figure 32

Figure 33



- Simultaneously, remove the two spring cups, then gradually release tension on the firing pin spring and remove it (Figure 32).
- Remove the spacer sleeve.
- When reassembling spring cups, make sure small end is inside the firing pin spring.

Notes: _____

VIII. RECEIVER DISASSEMBLY



Figure 34

Notes: _____

GLOCK 20, 21, 22, & 23

On the GLOCK 20, 21, 22 & 23 first remove the locking block pin from left to right (Figure 35).

The locking block pin (Item #34) should be the first pin removed and the first pin reinserted. If you install the locking block pin after inserting the slide stop lever, you will bend and damage the slide stop lever spring.

Trigger Pin Removal

- Use a pin punch to push the trigger pin from left to right (Figure 36).

Note:

To facilitate trigger pin removal, the slide stop lever should be moved forward and rearward while applying pressure on the trigger pin. (Do not use any excessive force, i.e. hammering to remove the trigger pin.) This will unhook the slide stop lever spring from the groove in the trigger pin. Always remove the trigger pin from left to right.

- Remove the trigger pin.

Slide Stop Lever Removal

- With the trigger pin removed, simply withdraw the slide stop lever by pulling it back (Figure 37).

Note:

When re-installing the slide stop lever in the pistol be sure it locks into the groove in the trigger pin. To function check the slide stop lever, lift it from its rest position and release it.

If the slide stop lever is properly installed and has engaged the groove in the trigger pin, the slide stop lever will snap back down into the rest position after being lifted and released.



Figure 35

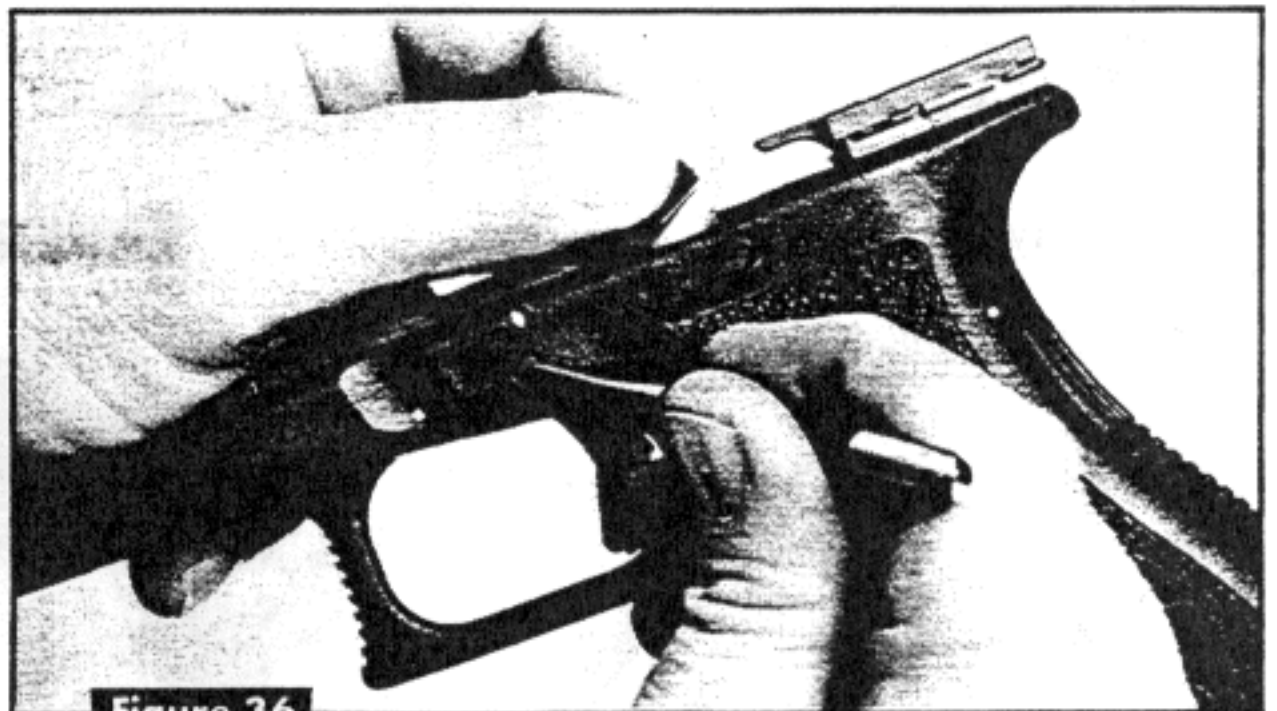

Figure 36

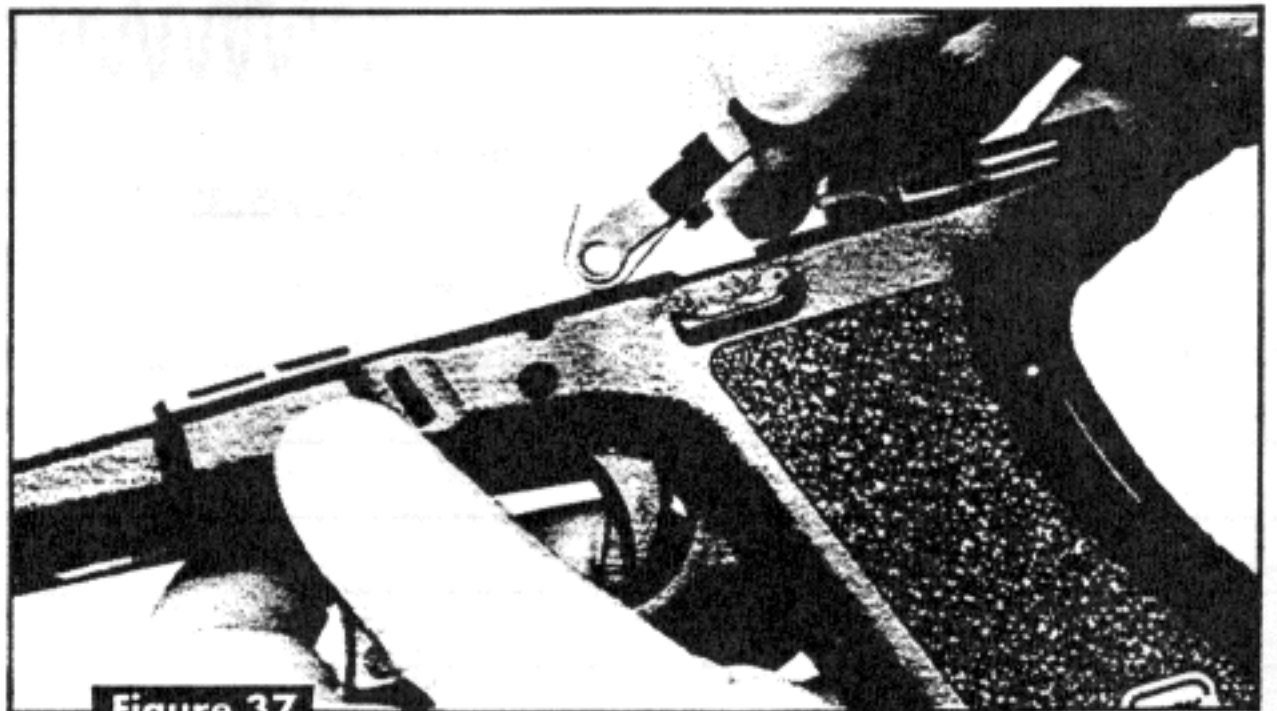

Figure 37

Locking Block Removal

- Use a pin punch or a screwdriver to raise the locking block (Figure 38).

Note:

Pry up from left side to prevent damage to trigger bar.

Notes: _____

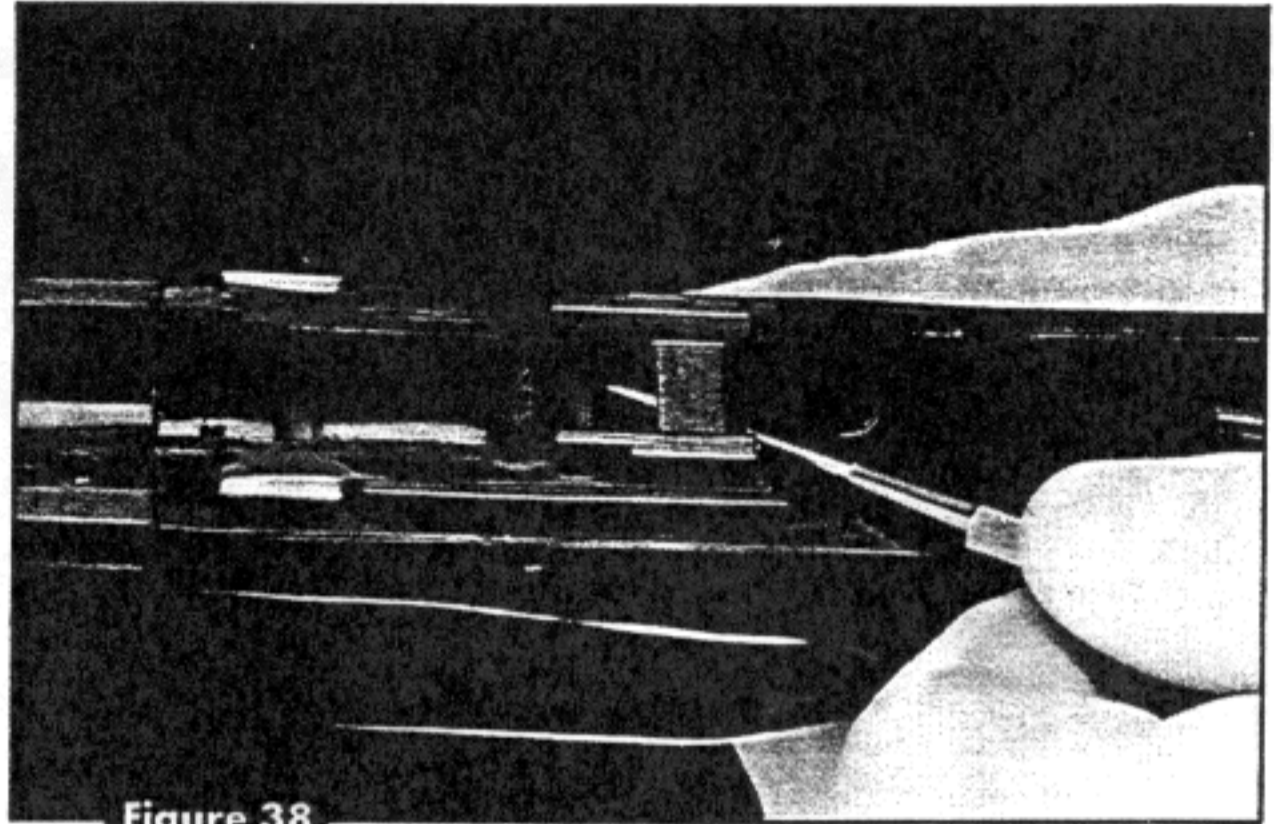

Figure 38

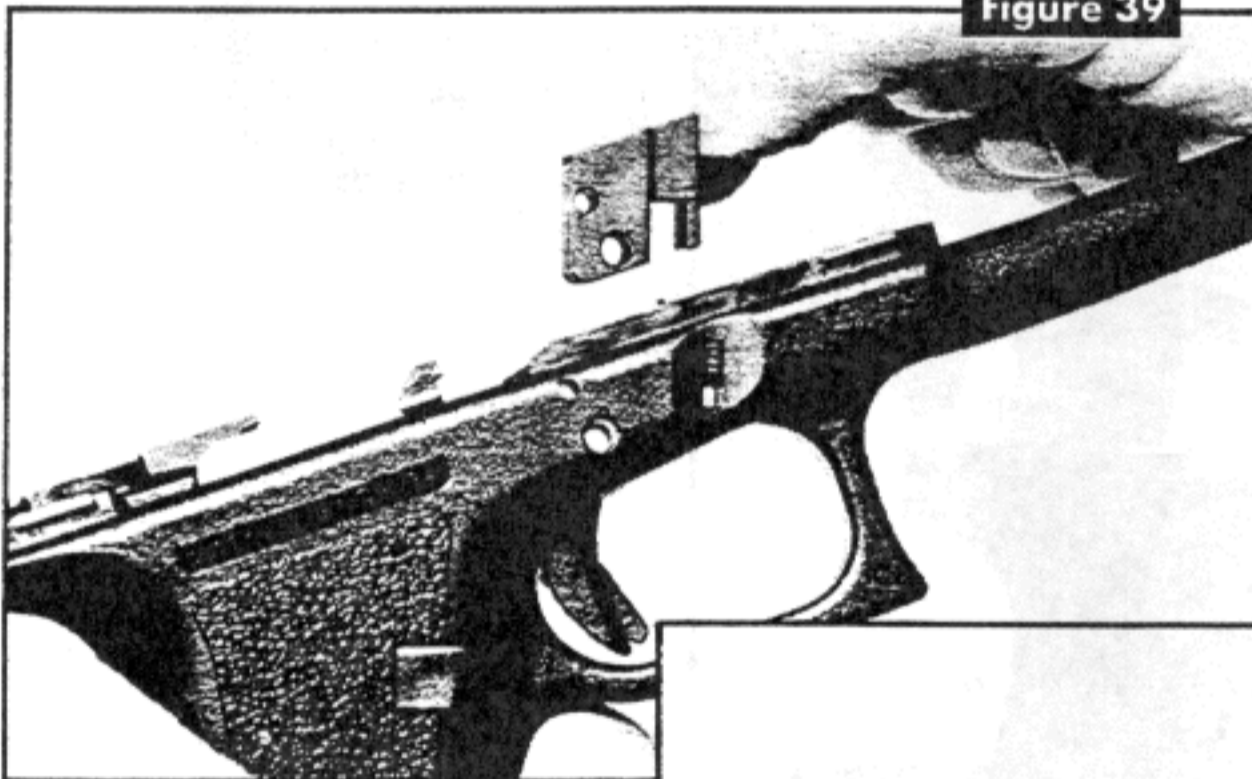

Figure 39

Then remove the locking block by hand (Figure 39).

Trigger Mechanism Housing Pin Removal

- Use a pin punch to push the trigger housing pin out of the frame (Figure 40).
- Remove the trigger housing pin.



Figure 40

Trigger Assembly Removal

- Using a pin punch, apply upward pressure under the ejector to raise the complete trigger assembly from the receiver as shown in Figure 41.

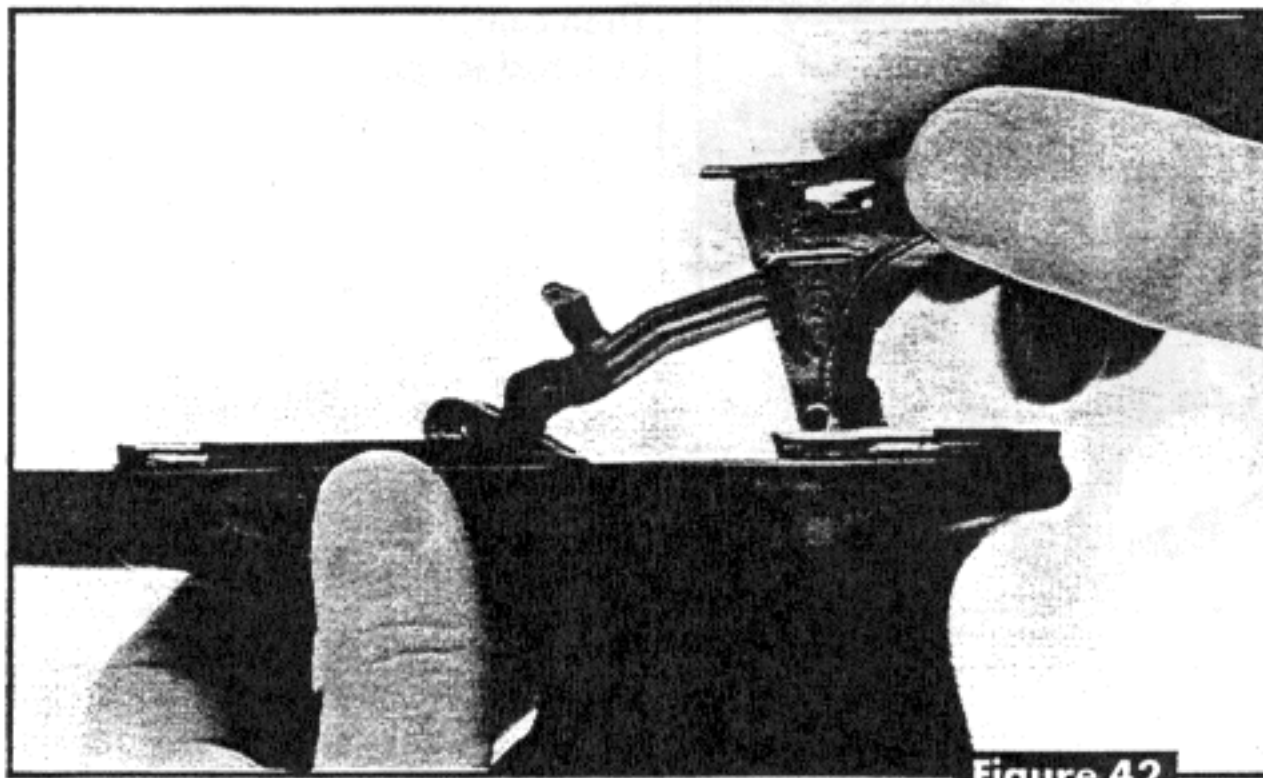
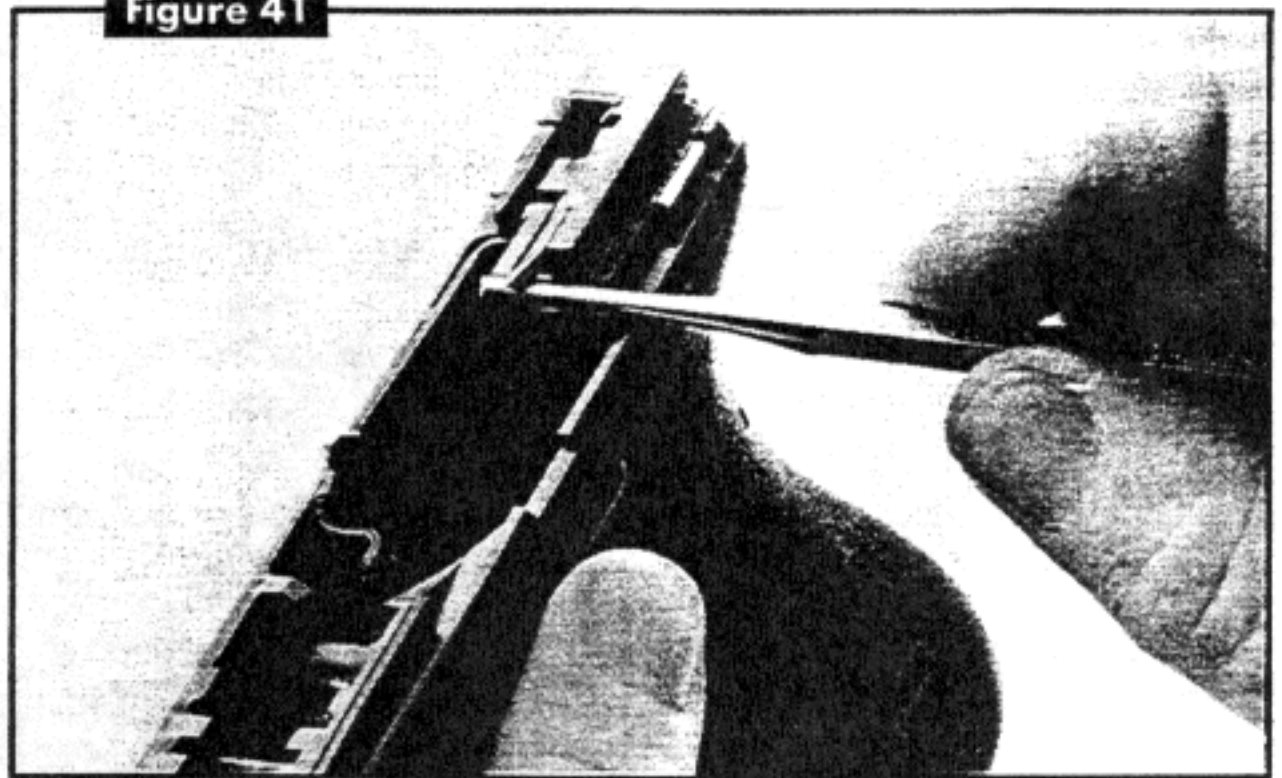

Then raise the rear most portion of the trigger assembly above the receiver and withdraw the complete assembly (Figure 42).

Notes: _____

Trigger Assembly Take-down

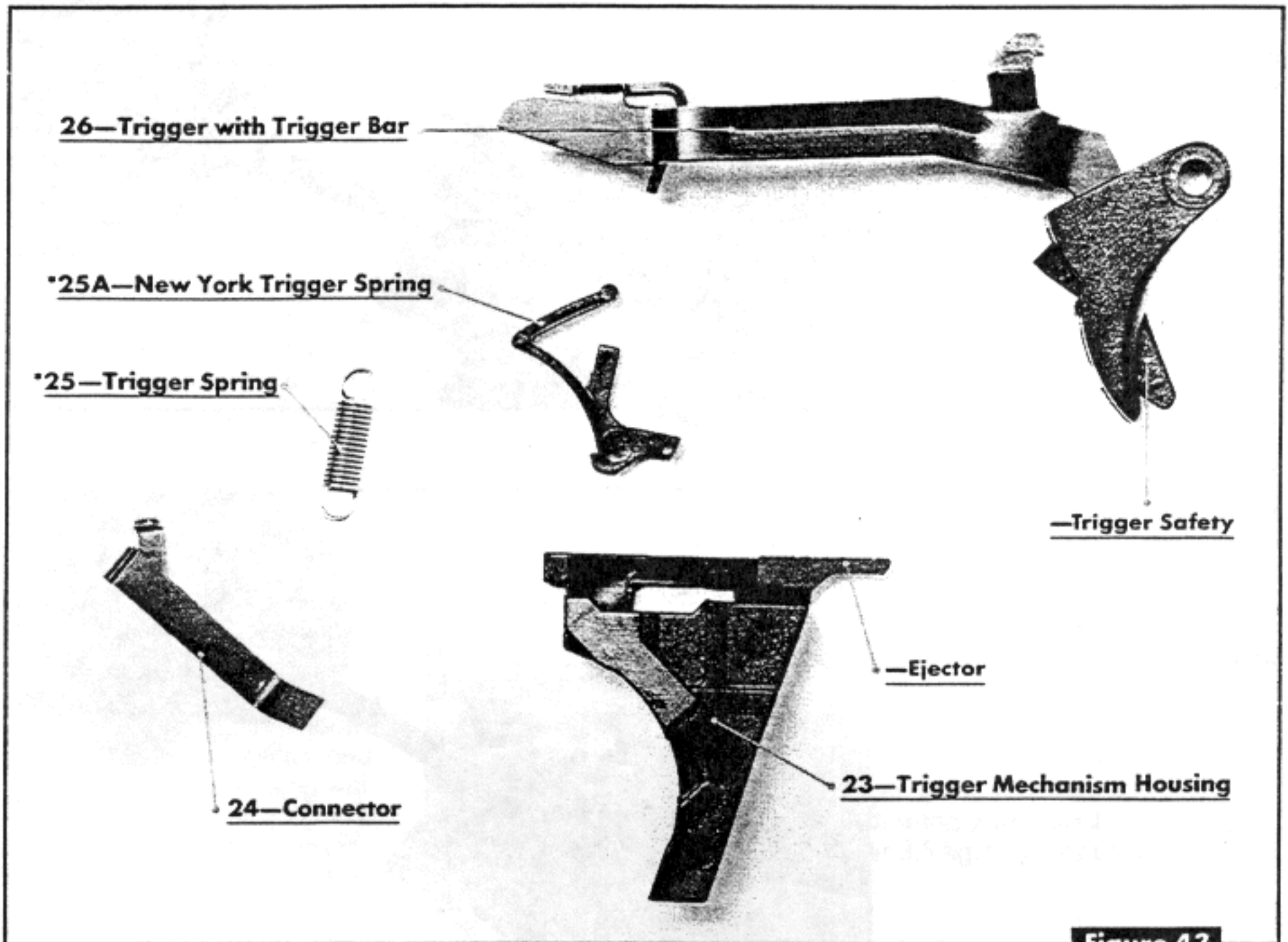

Figure 43

**Either the standard trigger spring or the New York Trigger Spring can be used.*

Notes: _____

Trigger Assembly Take Down

- Hold the trigger assembly as shown (Figure 44).



Figure 44

PULL forward on the trigger with trigger bar while rotating the trigger bar counterclockwise (Figure 45). The trigger with trigger bar can be lifted from the trigger mechanism housing.

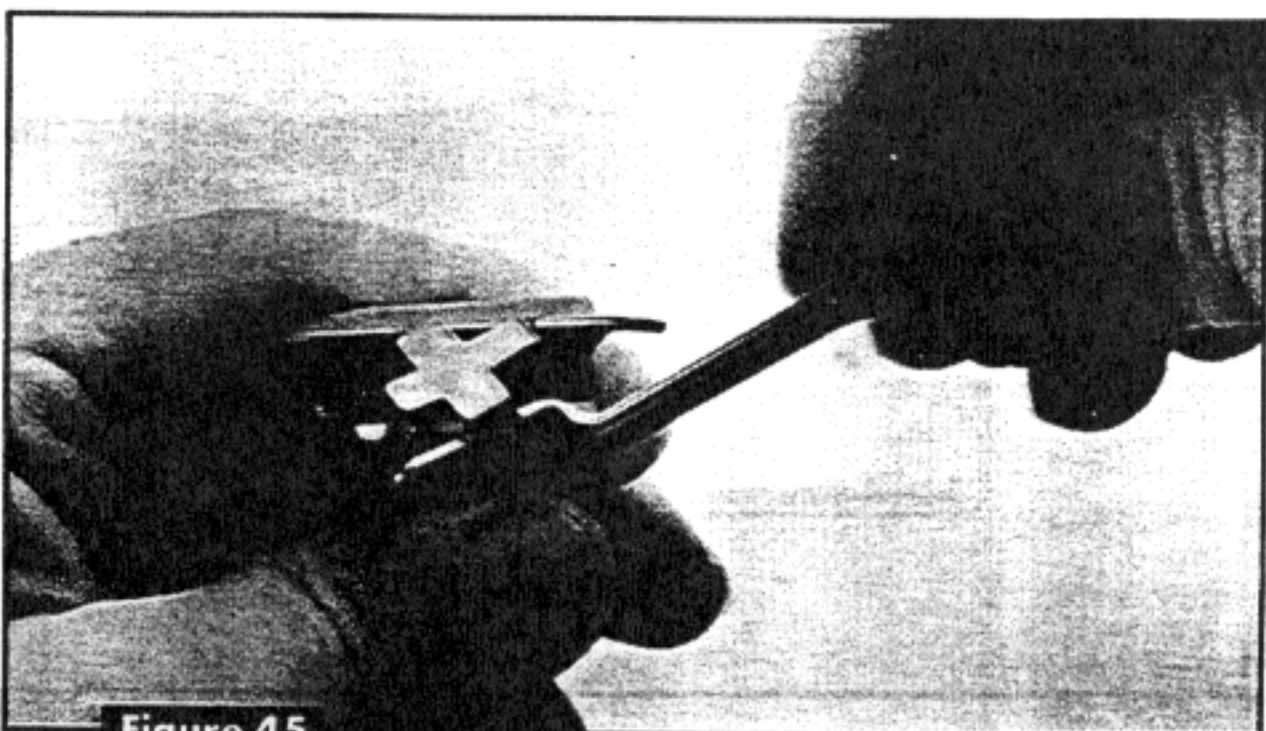

Figure 45

- REMOVE the connector as shown (Figure 46).
- SEPARATE the trigger with trigger bar from the coiled trigger spring by working the hooked end of the trigger spring off the trigger bar.
- SEPARATE the trigger mechanism housing from the trigger spring.

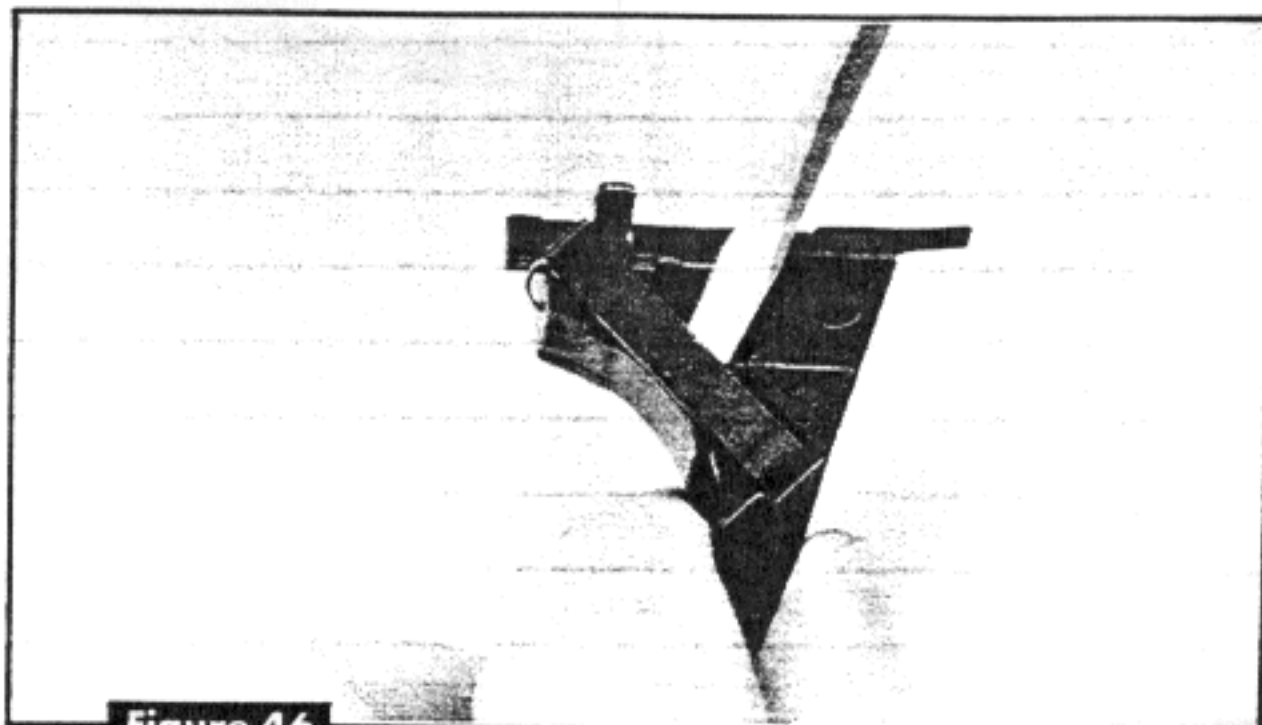

Figure 46

New York Trigger Spring

The New York Trigger Spring is produced in two weights. **Either spring should be installed only with the 5 lb. (2.5 kg) connector, neither should be installed with the 8 lb. (3.5 kg) connector.**

The standard New York Trigger Spring will increase the 5 lb. (2.5 kg) connector to a 7½ - 8½ (3.4 - 4.0 kg) trigger pull. The second or stronger version of the New York Trigger Spring (called New York Trigger "+") will increase the 5 lb. (2.5 kg) connector pull to 9 to 11 lbs. (4.1 - 5.0 kg).

Before installing a New York Trigger Spring in older Model Glock 17 and 19 pistols, be sure that the connector fits tightly in the trigger mechanism housing. If the connector *does not* fit tightly in the trigger mechanism housing then replace the connector and trigger mechanism housing with new parts that ensure a tight fit of the connector in the trigger mechanism housing. **The 8 lb.**

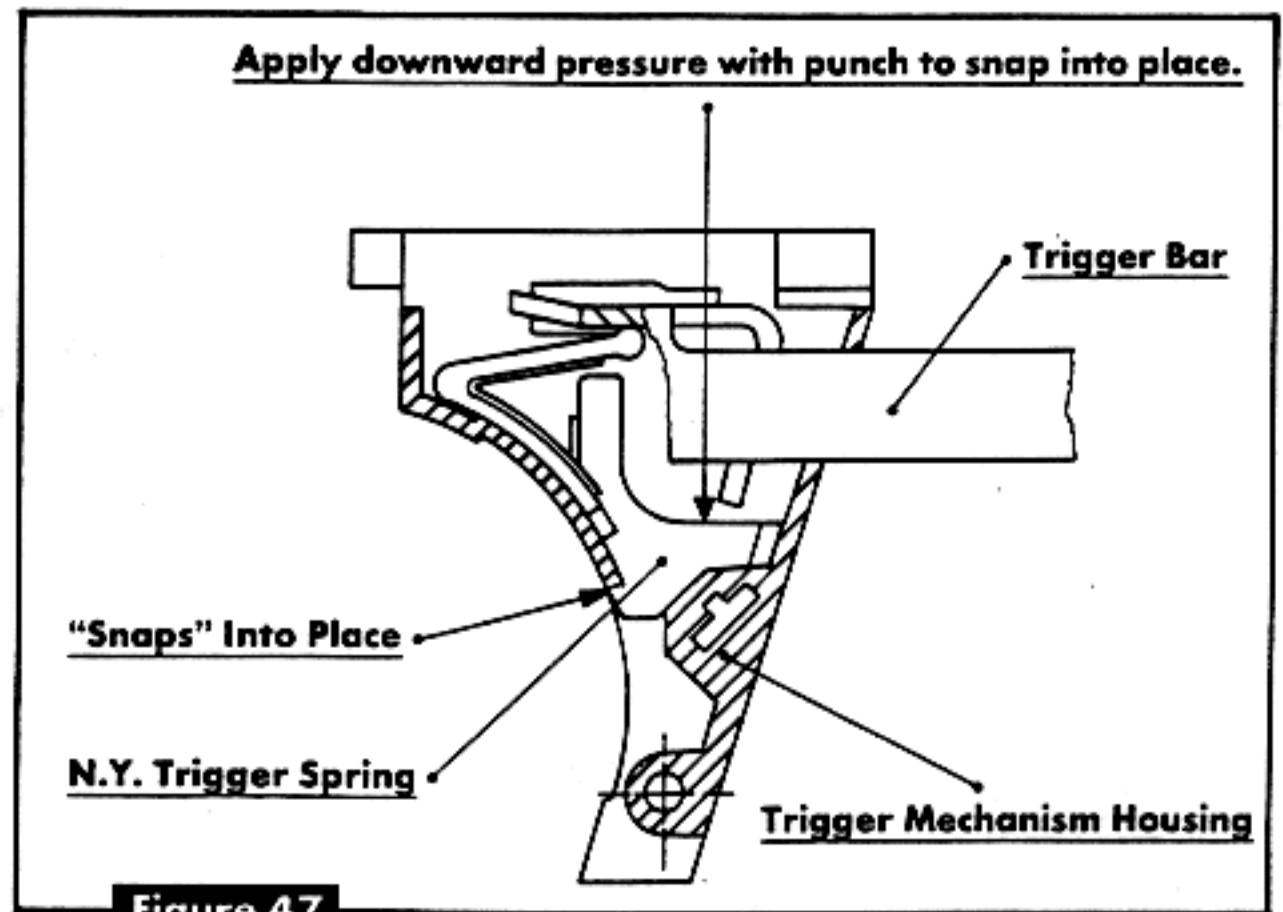

Figure 47

(3.5 kg) connector should never be installed with the New York Trigger Spring.

It is important that the connector be properly lubricated for proper functioning of the trigger. If not properly lubricated, the connector and/or trigger may be damaged and produce a hard

trigger pull, and should be replaced.

Glock will still offer the original 5 and 8 lb. (2.5 and 3.5 kg) trigger pulls with the standard coil trigger spring for those customers desiring a standard 5 or 8 lb. (2.5 or 3.5 kg) trigger pull.

Notes: _____

Slide Lock Removal

- While **PRESSING** the slide lock spring down as far as possible as shown (Figure 48), remove the slide lock (Figure 49). To facilitate removal of the slide lock, hold the frame of the pistol on its side while depressing the slide lock spring.

Figure 48

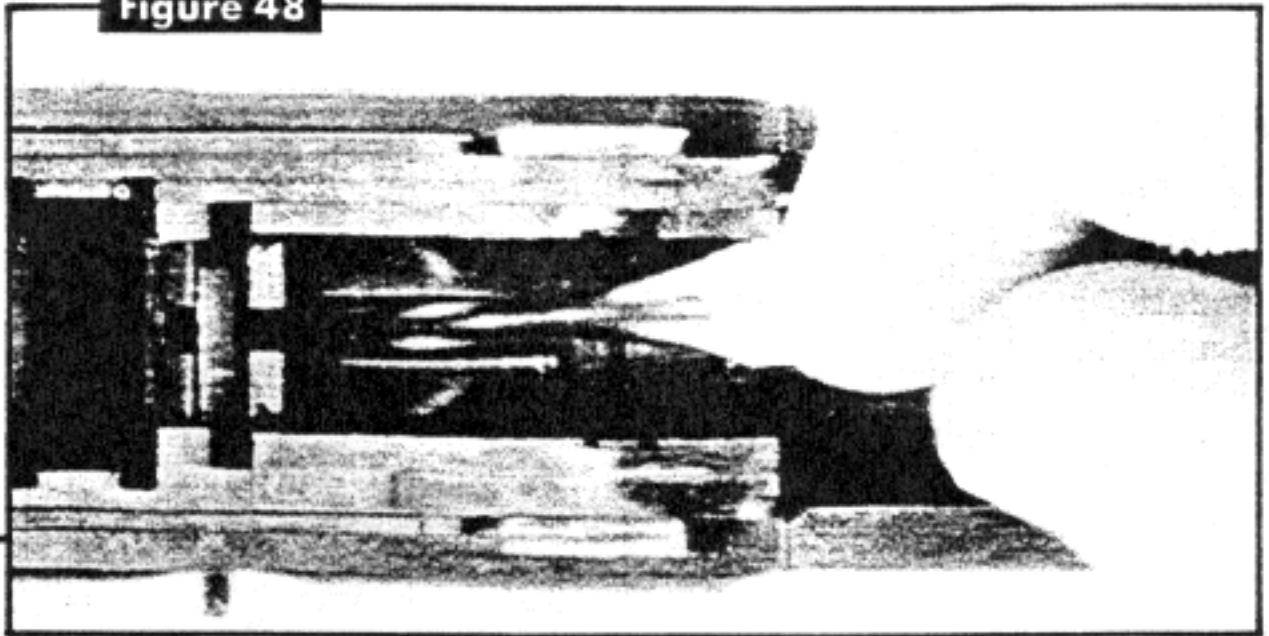
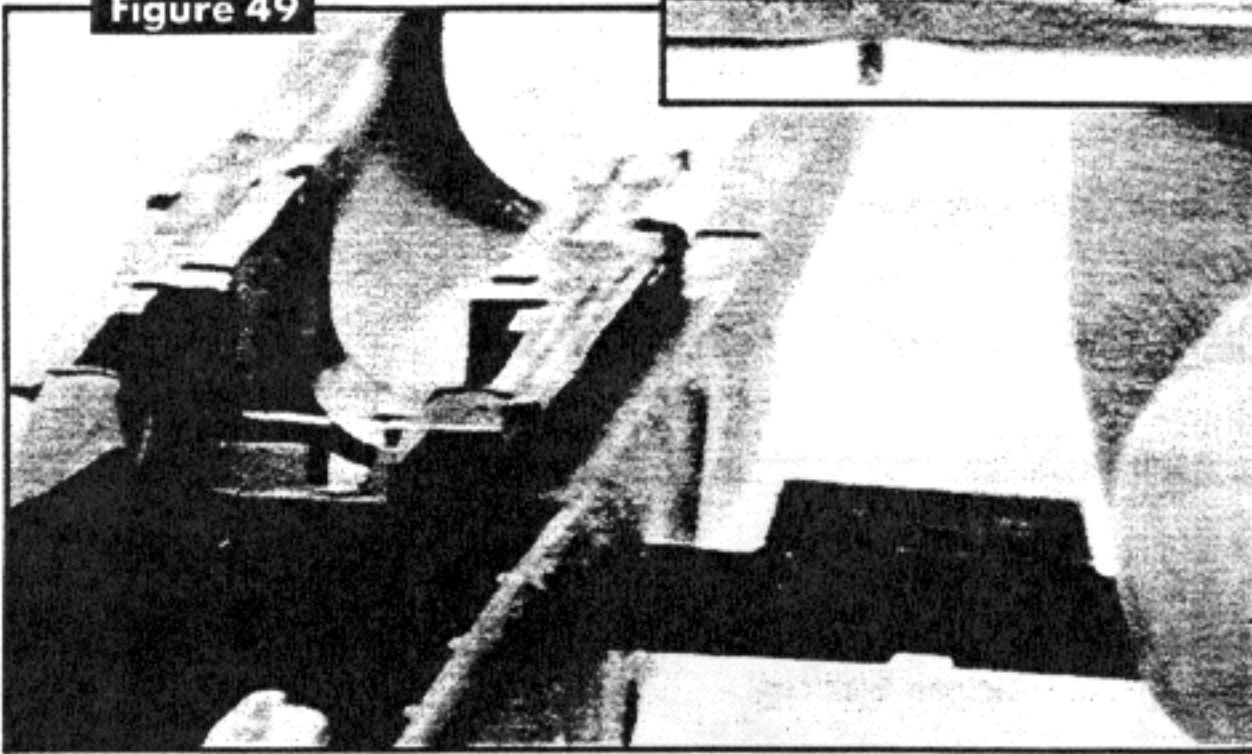
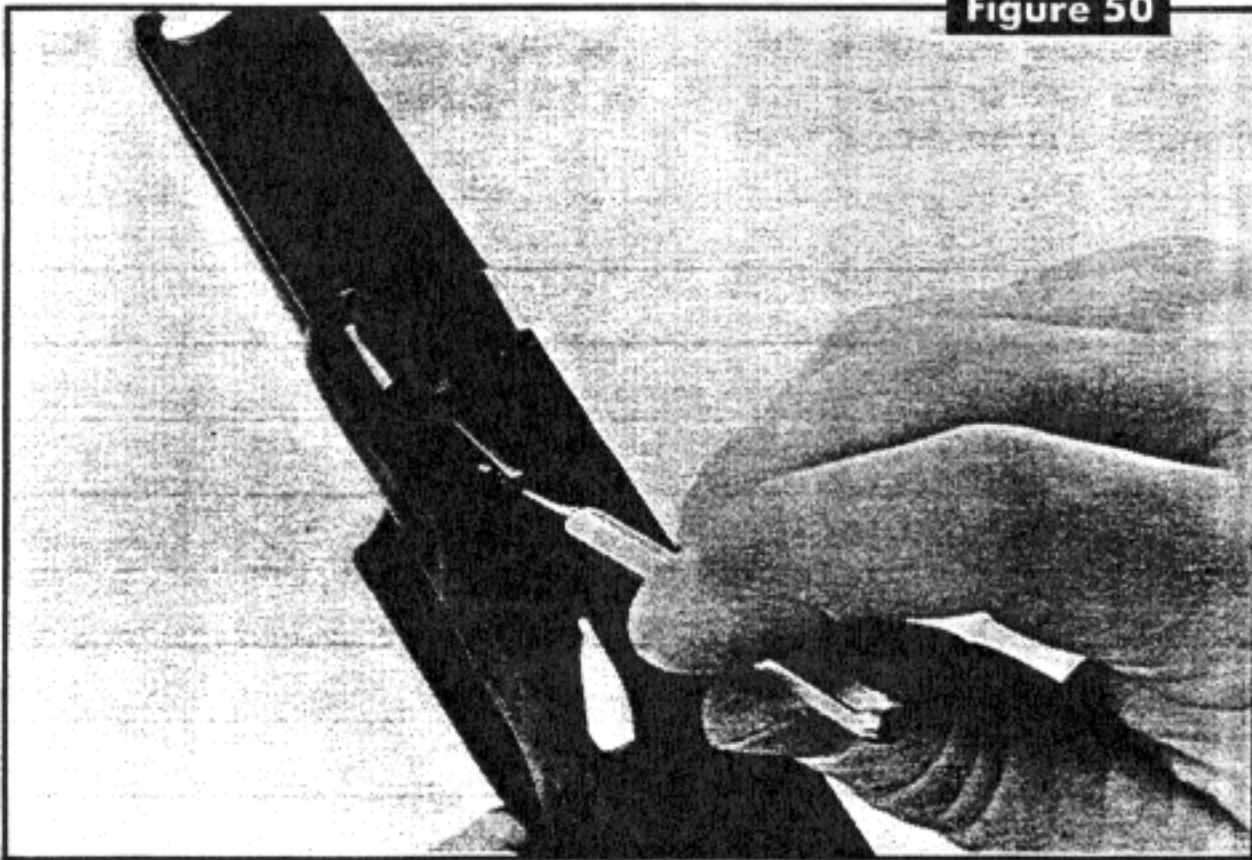

Figure 49



Notes: _____

Figure 50



Slide Lock Spring Removal

- **REMOVE** the slide lock spring by raising it from the frame with a pair of needle nose pliers or pin punch of 1/16" diameter or less as shown for full size pistols only. The slide lock spring for compact models tap out easily (Figure 50).

Notes: _____

Magazine Catch Removal

- Use a screwdriver to push the magazine catch spring out of the magazine catch groove as follows:

Be sure to press the right side of the magazine catch with a finger to prevent the magazine catch from moving

when starting to push the magazine catch spring out of the groove.

Start with the screwdriver to the left of the magazine catch spring (Figure 51). Push the spring to the right and then pry it out of the groove located on the bottom of the magazine catch.

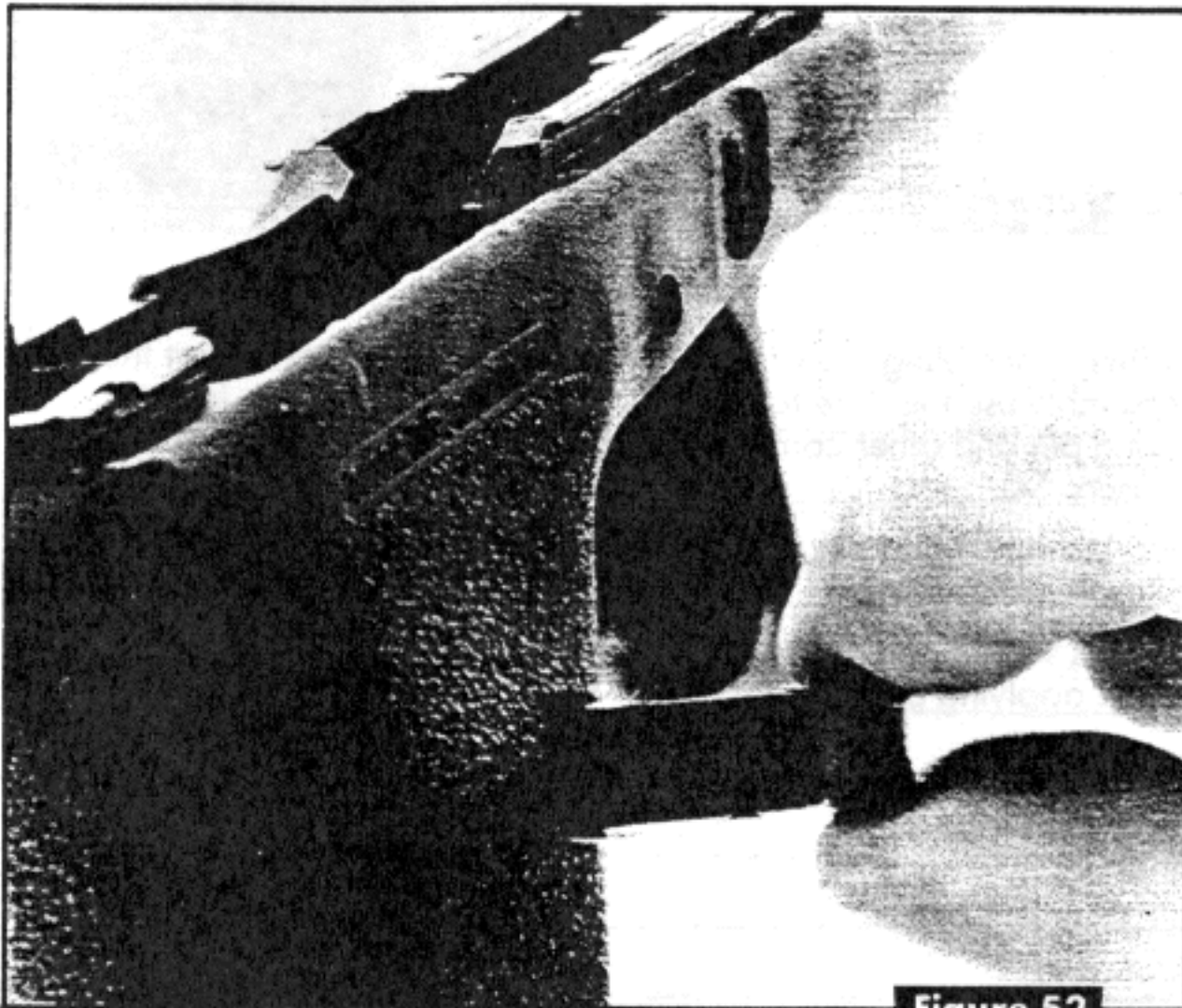

Figure 52

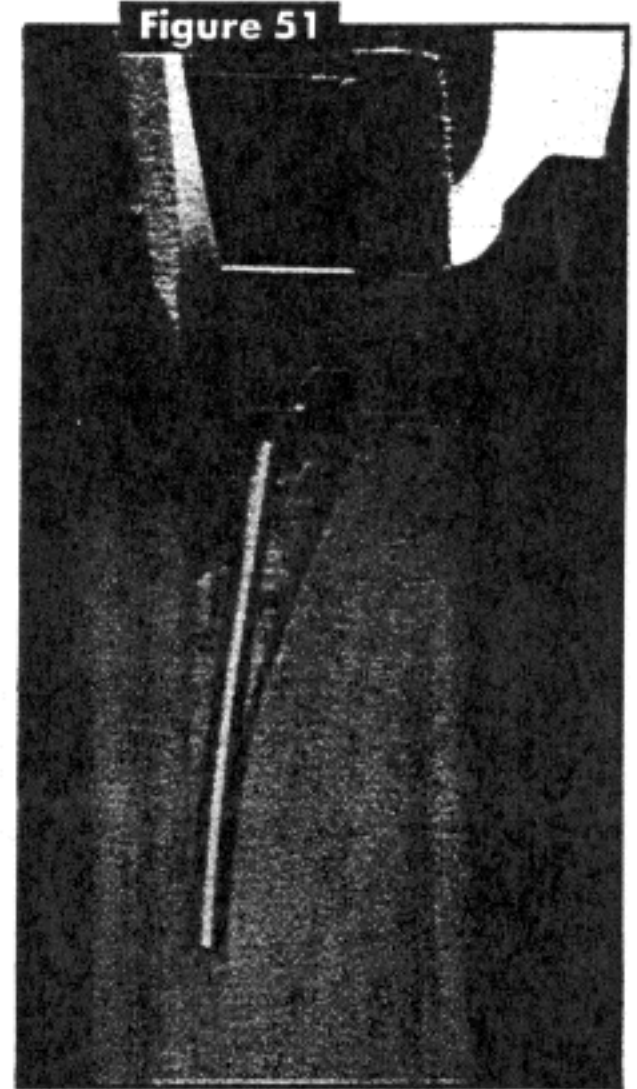

Figure 51

- REMOVE the magazine catch from the right side of the receiver (Figure 52).

Magazine Catch Spring Removal

- Using a pair of needle nose pliers, PULL the magazine catch spring straight up and remove it.

Notes: _____

IX. REASSEMBLY PROCEDURES

As with most firearms, reassembly is carried out in the reverse order. Several specific suggestions are provided below to facilitate reassembly.

The slide lock spring has a long and a short end. The short end is installed vertically into the frame (Figure 53).



Figure 54

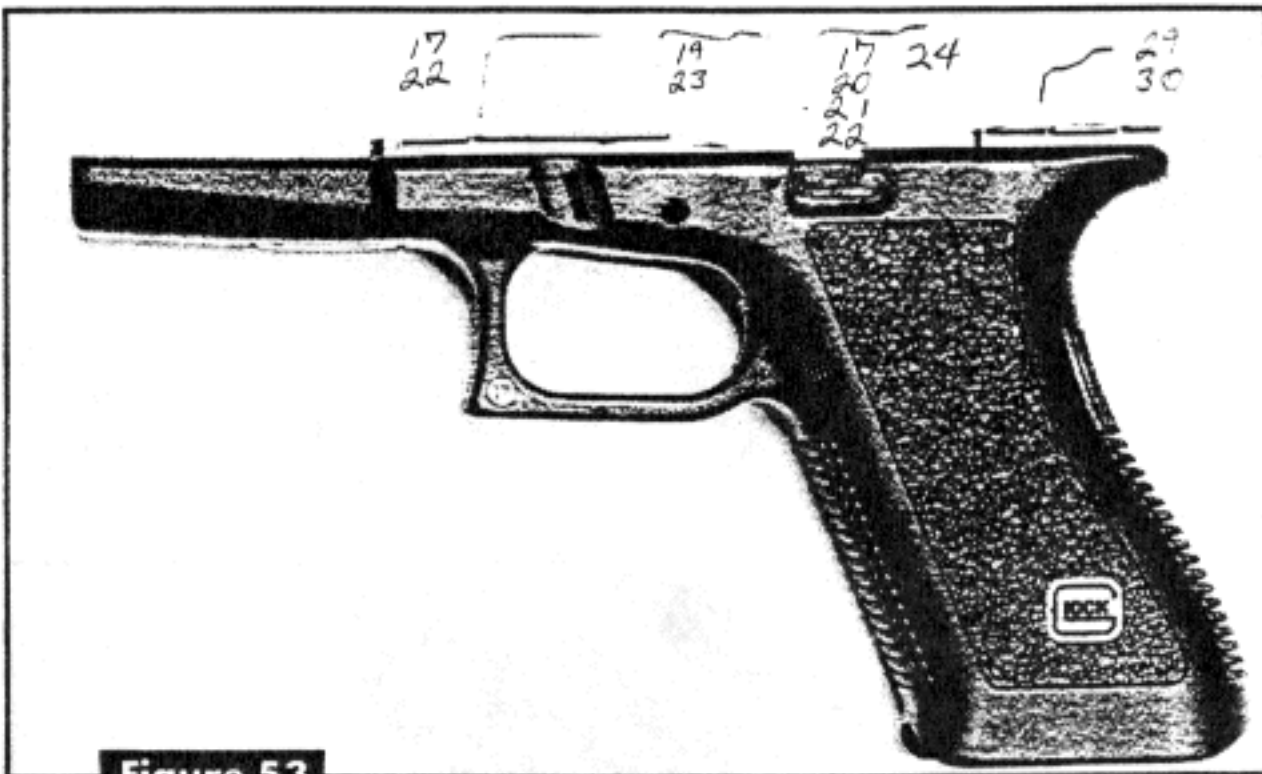

Figure 53

When assembling the firing pin assembly use the slide to hold the firing pin and other components (Figure 54).

To facilitate trigger pin installation, the slide stop lever should be moved slightly forward and back while applying pressure on the

trigger pin. Always insert the trigger pin from right to left.

Note:

When re-installing extractor depressor plunger make sure you have steel to steel and polymer to polymer.

Notes: _____

Figure 55

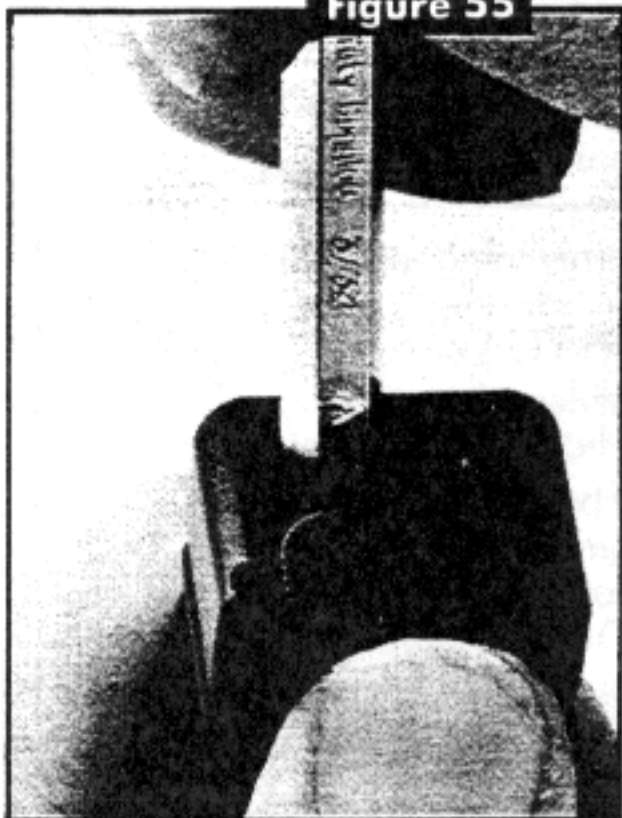

When replacing the slide cover plate use the back end of the punch to depress the firing pin assembly as the plate is pushed inwards (Figure 55).

Then use the tip of the pin punch to depress the spring loaded bearing, compressing the extractor depressor plunger spring while pushing the cover plate into its fully locked position (Figure 56).

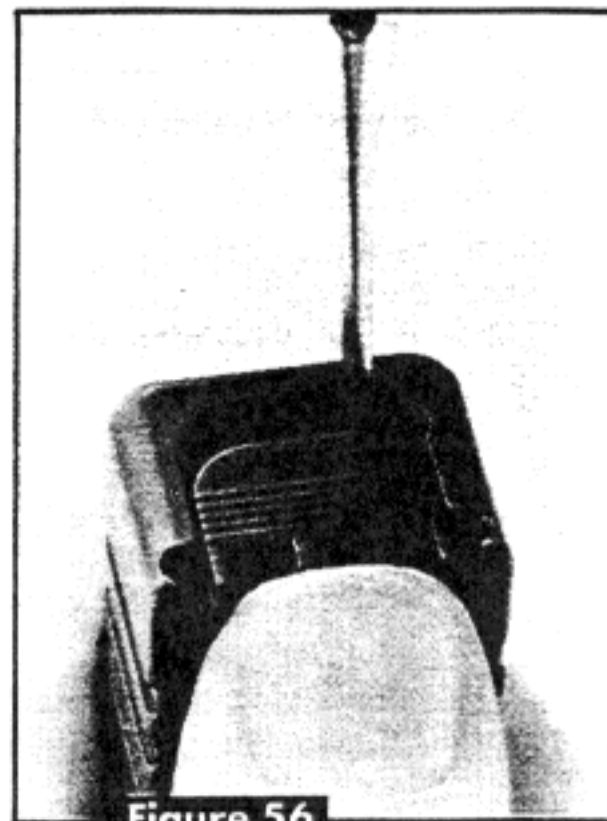

Figure 56

Notes:

X. FRONT AND REAR SIGHT REMOVAL & INSTALLATION

Front Sight Removal

- To remove the front sight from the slide, position the front of the slide in upside down position over the edge of a table or workbench. While firmly holding the slide on the workbench, tap the front sight from the slide with a pin punch and small hammer (or, the slide may be held in a vice to perform this procedure. If a vice is used, be sure that protective jaw covers are used so as not to damage the slide).

Front Sight Installation

- INSERT a new front sight into the front sight slot and press it flush with the top surface of the slide.
- The new front sight should be placed on a smooth wood or plastic surface after it has been inserted into the slide to be sure it is not pushed out of the slide when inserting the fixing pin.
- INSERT a fixing pin in the slot in the base of the front sight, by hand or with the aid of long nose pliers.
- With a pin punch and a small hammer tap the fixing pin into the base of the front sight (Figure 57).

Rear Sight Removal

Drift or press the rear sight out of its dovetail slot.

Rear Sight Installation

Follow instructions furnished with the GLOCK rear sight installation/adjustment tool.

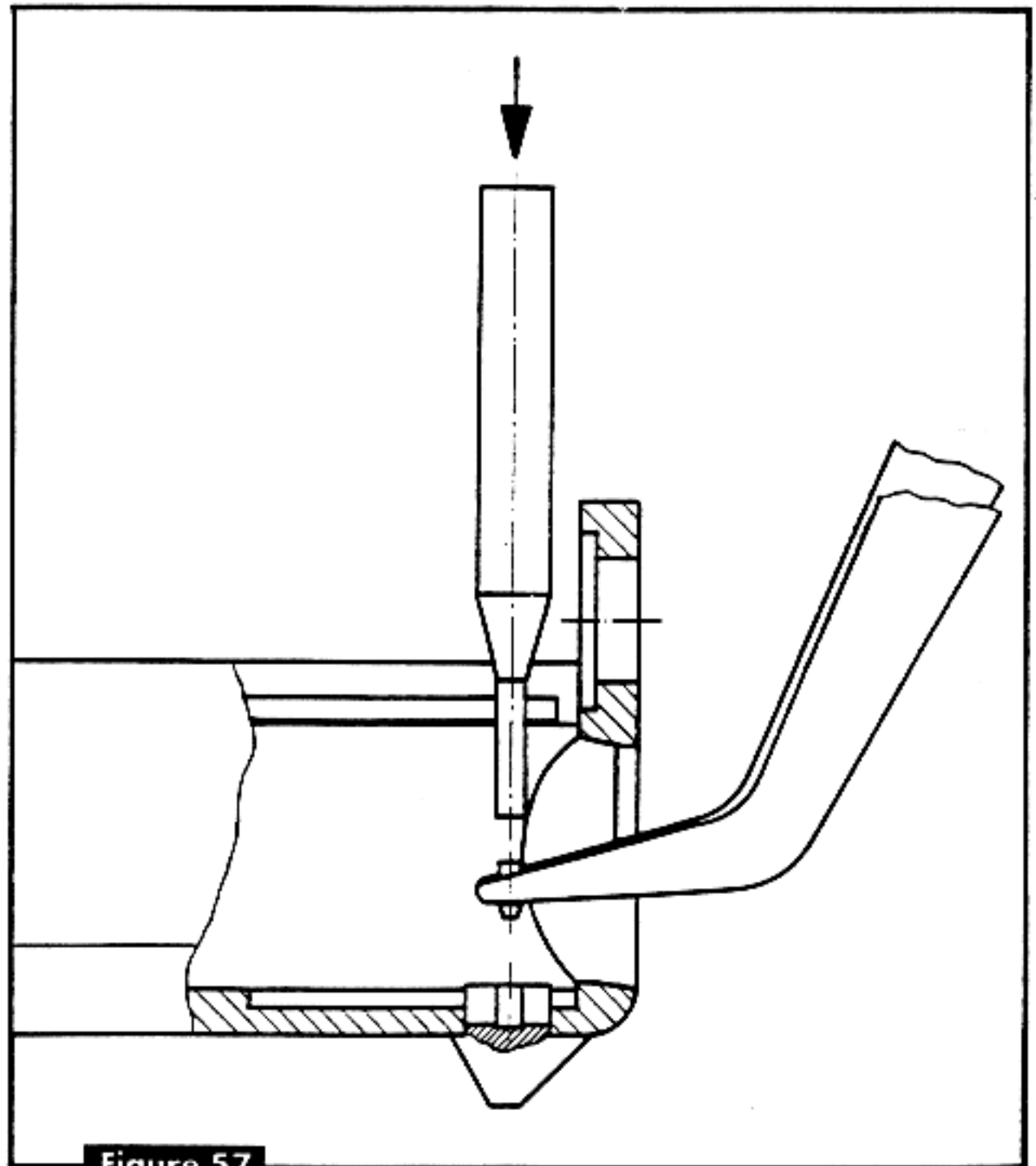

Notes: _____



SIGHT INSTALLATION DEVICE

HOW to OPERATE the GLOCK INSTALLATION and ADJUSTMENT DEVICE for REAR SIGHTS

For use with: GLOCK 17, GLOCK 17L, GLOCK 19, GLOCK 22 and GLOCK 23.

CAUTION: Before installing or adjusting rear sights, BE SURE that your pistol is UNLOADED, with the MAGAZINE REMOVED. Strictly obey the following INSTALLATION SAFETY PRECAUTIONS:

Remove magazine while pointing pistol in safe direction (with finger off the trigger). Lock the slide to the rear by pushing up on the slide stop lever while pushing the slide to the rear.

Once the slide is locked to the rear, then both visually and tactilely inspect the chamber to verify that the chamber is empty. You may now proceed with normal field stripping. Refer to your GLOCK owners manual for field stripping instructions if you are not familiar with the proper method to field strip a GLOCK pistol.

Once the slide is removed from the frame, then remove the recoil spring, recoil spring tube and the barrel before attaching the slide to the slide rail plate assembly (G).

GLOCK INSTALLATION and ADJUSTMENT DEVICE for REAR SIGHTS:

- Allows
 - removal of rear sight
(all original GLOCK types are available with Tritium night sights)
 - mounting of new rear sight
(all original GLOCK types are available with Tritium night sights)
 - adjustment (lateral)
- GLOCK 17, 17L, 19, 22, and 23 sight installation device
- The sight installation device for the GLOCK 20 and GLOCK 21 is larger but still operates in the same manner.

NOTE: If you wish to shift the point of impact on your target to the left, you have to move the rear sight to the left and vice versa for the right (left and right in muzzle direction).

Point of impact	Direction in which to move rear sight
left of center	right
right of center	left
low	insert higher rear sight
high	insert lower rear sight

NOTE: Following sizes of original GLOCK rear sights are available:

Sight marking	Height (mm/in)	Remark
	7.3 / 0.29"	highest impact
	6.9 / 0.27"	high impact
	6.5 / 0.256"	standard factory issue
	6.1 / 0.24"	lower impact
	6.1 to 7.3 0.20" to 0.24"	click adjustable sight



NOTE: For proper operation of the Glock sight installation device, a drop of quality lubricating oil should be applied between the **end play nuts** (E). A drop of quality lubricating oil should be applied to the **drive screw** (D) and the drive screw run back and forth allowing the oil to penetrate the internal threads of the **sight carrier** (B).

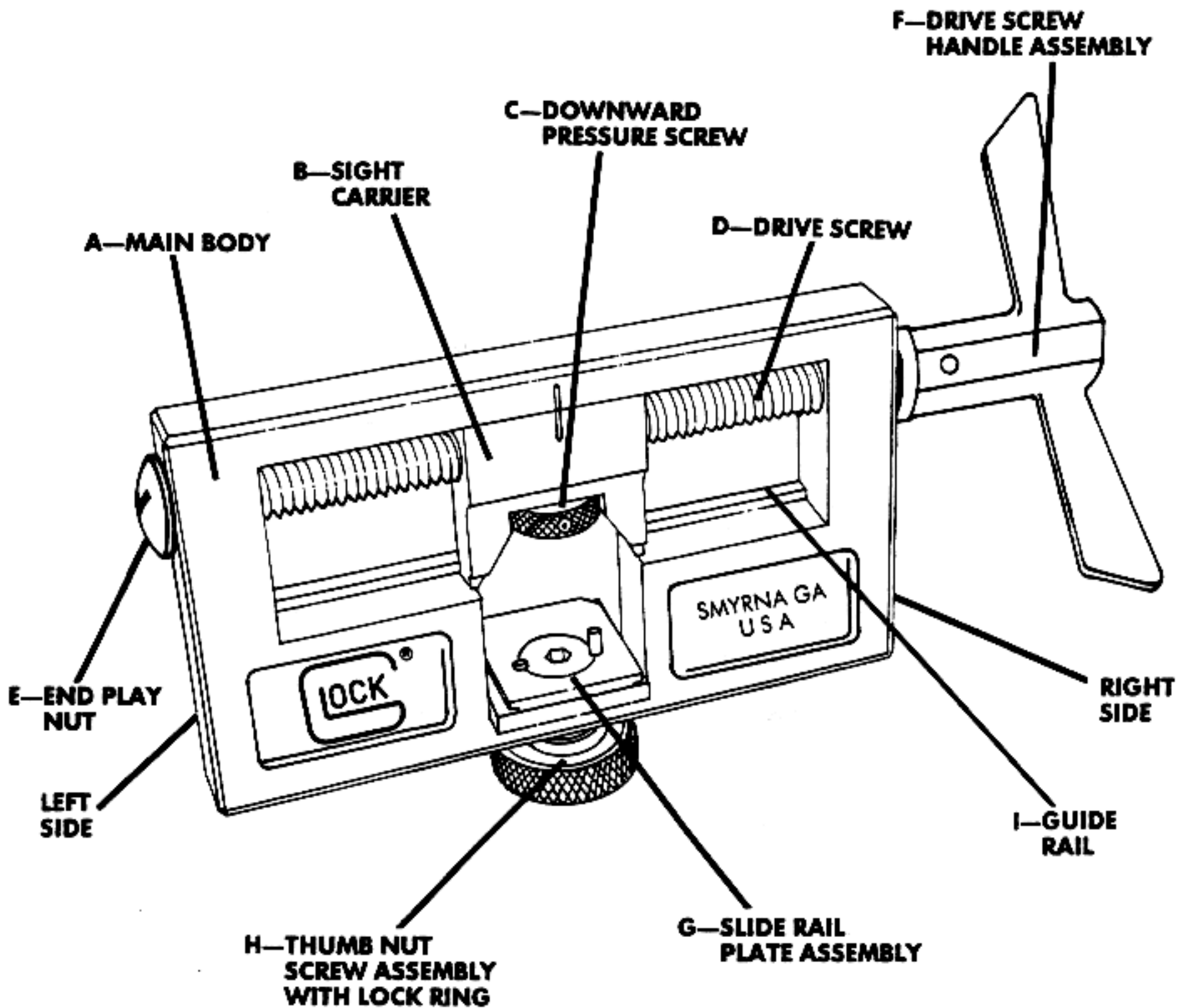

Proper Glock slide placement
in sight installation device

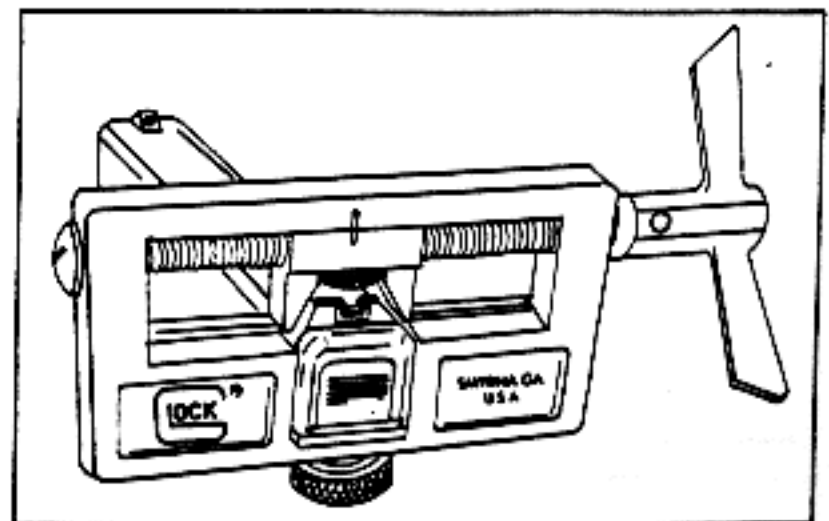



To Adjust Rear Sight For Windage

After loosening the slide rail plate assembly (G) with the thumb nut (H), then center sight carrier so that marks on body (A) and Sight Carrier (B) align, place slide in slide rail plate assembly (G) by aligning the slide rail cuts with the slide rail plate assembly. Push the slide to the rear until the camming cut in the slide contacts the pin protruding from the right side of the slide rail plate assembly (G), tighten thumb nut (H). Turning handle (F) clockwise will move rear sight to the right and vice versa.

To Replace Polymer Rear Sight

Turn handle (F) counter clockwise to move carrier to left center of window. Insert slide rail cuts in slide rail plate (G), tighten thumb nut (H), insert new Glock sight in carrier making sure to seat new sight back against guide rail (I). Turn downward pressure screw (C) to bear firmly against top of new sight making sure white outline is facing in right direction. Turn handle (F) clockwise removing old sight, and installing new one simultaneously.

Rear Night Sight Installation

Same procedure as with polymer rear sight, except no downward pressure is required. Be sure the luminous vials face to the rear.

Front Night Sight Installation

Position front sight in slot, apply lock-tight, tighten screw snug. Do not over tighten or screw will snap or break.

Note

When replacing broken night sight with new one you must center sight carrier (B), install slide in slide rail plate (G), tighten thumb nut (H), push old metal sight out, place new night sight in carrier and install in normal manner, never push metal sights with outside edge of carrier.

SERVICE PROCEDURES AND TROUBLE SHOOTING

Observed Problem	Probable Causes	Corrections
STOPPAGES:		
Failure to extract	Extractor worn/broken/missing Over-powered or under-powered defective ammunition Dirt under extractor claw Dirty chamber Shooting with an unlocked wrist	Replace Change ammunition Clean extractor and check function Clean chamber Lock shooting hand wrist
Failure to eject or erratic ejection (including stove pipes)	Broken or damaged ejector Under-powered ammunition Dirty chamber Shooting with an unlocked wrist Lack of lubrication Dirty gun	Replace Trigger mechanism housing with ejector Change ammunition Clean chamber Lock shooting hand wrist Lubricate Clean
Failure to feed	Magazine not properly inserted Under-powered ammunition Dirty magazine Weak magazine spring Dirty chamber Tight extractor Limp wrist Deformed magazine Weak recoil spring	Reinsert magazine Change ammunition Clean and inspect magazine Replace if necessary Lock wrist Magazine sides or lips deformed —replace magazine Replace
Slide fails to lock open on last round	Magazine follower broken Dirty magazine Weak magazine spring Worn slide stop lever notch Dirty gun Needs lubrication Deformed magazine Under-powered ammunition Limp wrist Trigger pin inserted too far Improper grip Slide stop lever worn Slide stop lever damaged	Replace follower Clean and inspect magazine Replace if necessary Magazine sides deformed by attempting to load too many rounds—replace magazine The trigger pin may be inserted too far to the left. This can cause the spring on the slide stop lever to bind. Check to see if the slide stop lever moves freely. If not, press the trigger pin slightly to the right until the slide stop lever moves freely. Inspect and replace if necessary.

SERVICE PROCEDURES AND TROUBLE SHOOTING (cont.)

Observed Problem	Probable Causes	Corrections
Failure to Fire No primer strike: Light, centered strike:	Slide out of battery (DO NOT FORCE INTO BATTERY) due to: Deformed/defective round Under-powered ammunition Damaged/weak recoil spring Damaged recoil spring tube Mating surfaces of barrel, slide and receiver excessively dirty. Gun dirty/obstructed chamber Shooting with an unlocked wrist Hard primer (SMG ammunition) Obstructed firing pin channel	Inspect and replace round Change ammunition Replace recoil spring Replace recoil spring tube Field-strip and clean Clean chamber Lock shooting hand wrist Change ammunition Remove, inspect and clean firing pin and firing pin spring. Clean firing pin channel.
Inconsistent trigger pull or will not release	Connector loose in housing Pistol is excessively dirty Wrong trigger bar Connector needs lubrication Trigger bar is bent/damaged	Replace housing Field strip and clean. Replace Oil Replace trigger bar.
Trigger safety fails to return to engaged (forward) position	Improperly stored in original box with trigger in full forward position—(trigger safety fully depressed)	<i>Replace trigger bar. When stored in original box, pistol must be unloaded, trigger in back position.</i>
Firing pin safety fails functional test as described in the manual:	Damaged, worn or defective firing pin safety	Replace firing pin safety and firing pin
No primer strike	Worn or broken firing pin tip. Obstructed channel Spring cups inverted	Replace Clear Change
Light off-center strike	Tight extractor Dirty gun Slide lock reversed or not beveled	Change Clean Replace
Locks open early	Improper hand position Reverse tension on slide stop lever spring Damaged slide stop lever	Change grip Replace Replace

GLOCK PARTS AND ACCESSORIES: GLOCK 17

PART NUMBER	GLOCK PISTOL DESCRIPTION	QTY. ORDERED	UNIT COST	TOTAL COST
3598	Slide			
3570	Barrel			
1533	Recoil Spring Assembly			
49	Firing Pin			
56	Spacer Sleeve			
63	Firing Pin Spring			
70	Spring Cups			
84	Firing Pin Safety			
91	Firing Pin Safety Spring			
98	Extractor			
112	Extractor Depressor Plunger			
119	Extractor Depressor Plunger Spring			
126	Spring Loaded Bearing			
133	Slide Cover Plate			
182	Fixed Rear Sight 6.5mm			
154	Fixed Rear Sight 6.1mm			
196	Fixed Rear Sight 6.9mm			
210	Fixed Rear Sight 7.3mm			
791	Click Adjustable Rear Sight			
224	Front Sight			
3549	Receiver (Frame)			
280	Magazine Catch Spring			
287	Magazine Catch			
1981	Extended Magazine Catch			
294	Slide Lock Spring			
301	Slide Lock			
308	Locking Block			
322	Trigger Mechanism Housing with Ejector			
343	Connector (5 lb.) 2.5 kg (stand.)			
735	Connector (8 lb.) 3.5 kg			
350	Trigger Spring			
357	Trigger with Trigger Bar			
399	Slide Stop Lever with Spring			
420	Trigger Pin			
427	Trigger Mechanism Housing Pin			
441	Follower			
448	Magazine Spring			
455	Magazine Floor Plate with Hole			
5572	Magazine Insert			
1113	Magazine Tube			
483	Loading Device			
4200	Plastic Box for Pistol			
490	Cleaning Rod			
497	Cleaning Brush (Nylon)			
3661	New York Trigger Spring			
5418	New York Trigger Spring Plus			
1148	Firing Pin Channel Liner			
	Other _____			
	TOTAL			

GLOCK PARTS AND ACCESSORIES: GLOCK 17L

PART NUMBER	GLOCK PISTOL DESCRIPTION	QTY. ORDERED	UNIT COST	TOTAL COST
3654	Slide			
3633	Barrel			
1533	Recoil Spring Assembly			
49	Firing Pin			
56	Spacer Sleeve			
63	Firing Pin Spring			
70	Spring Cups			
84	Firing Pin Safety			
91	Firing Pin Safety Spring			
98	Extractor			
112	Extractor Depressor Plunger			
119	Extractor Depressor Plunger Spring			
126	Spring Loaded Bearing			
133	Slide Cover Plate			
182	Fixed Rear Sight 6.5mm (Stand.)			
154	Fixed Rear Sight 6.1mm			
196	Fixed Rear Sight 6.9mm			
210	Fixed Rear Sight 7.3mm			
791	Click Adjustable Rear Sight			
224	Front Sight			
3549	Receiver (Frame)			
280	Magazine Catch Spring			
287	Magazine Catch			
1981	Extended Magazine Catch			
294	Slide Lock Spring			
301	Slide Lock			
308	Locking Block			
322	Trigger Mechanism Housing with Ejector			
721	Connector (3 lb.) 2.0 kg (17L only)			
343	Connector (5 lb.) 2.5 kg (stand.)			
735	Connector (8 lb.) 3.5 kg			
350	Trigger Spring			
357	Trigger with Trigger Bar			
399	Slide Stop Lever with Spring			
420	Trigger Pin			
427	Trigger Mechanism Housing Pin			
441	Follower			
448	Magazine Spring			
455	Magazine Floor Plate with Hole			
5572	Magazine Insert			
1113	Magazine Tube			
483	Loading Device			
4228	Plastic Box for Pistol			
490	Cleaning Rod			
497	Cleaning Brush (Nylon)			
3661	New York Trigger Spring			
5418	New York Trigger Spring Plus			
1148	Firing Pin Channel Liner			
	Other _____			
	TOTAL			

GLOCK PARTS AND ACCESSORIES: GLOCK 19

PART NUMBER	GLOCK PISTOL DESCRIPTION	QTY. ORDERED	UNIT COST	TOTAL COST
3612	Slide			
3577	Barrel			
2457	Recoil Spring Assembly			
49	Firing Pin			
56	Spacer Sleeve			
63	Firing Pin Spring			
70	Spring Cups			
84	Firing Pin Safety			
91	Firing Pin Safety Spring			
98	Extractor			
112	Extractor Depressor Plunger			
119	Extractor Depressor Plunger Spring			
126	Spring Loaded Bearing			
133	Slide Cover Plate			
182	Fixed Rear Sight 6.5mm (Stand.)			
154	Fixed Rear Sight 6.1mm			
196	Fixed Rear Sight 6.9mm			
210	Fixed Rear Sight 7.3mm			
791	Click Adjustable Rear Sight			
224	Front Sight			
3563	Receiver (Frame)			
280	Magazine Catch Spring			
287	Magazine Catch			
1981	Extended Magazine Catch			
2317	Slide Lock Spring			
301	Slide Lock			
2471	Locking Block			
322	Trigger Mechanism Housing with Ejector			
343	Connector (5 lb.) 2.5 kg (Stand.)			
735	Connector (8 lb.) 3.5 kg			
350	Trigger Spring			
2303	Trigger with Trigger Bar			
2919	Slide Stop Lever with Spring			
420	Trigger Pin			
427	Trigger Mechanism Housing Pin			
441	Follower			
2429	Magazine Spring			
455	Magazine Floor Plate with Hole			
5572	Magazine Insert			
2443	Magazine Tube			
483	Loading Device			
4200	Plastic Box for Pistol			
490	Cleaning Rod			
497	Cleaning Brush (Nylon)			
3661	New York Trigger Spring			
5418	New York Trigger Spring Plus			
1148	Firing Pin Channel Liner			
	Other _____			
TOTAL				

GLOCK PARTS AND ACCESSORIES: GLOCK 20

PART NUMBER	GLOCK PISTOL DESCRIPTION	QTY. ORDERED	UNIT COST	TOTAL COST
5341	Slide			
5355	Barrel			
5586	Recoil Spring Assembly			
4557	Firing Pin			
56	Spacer Sleeve			
63	Firing Pin Spring			
70	Spring Cups			
84	Firing Pin Safety			
91	Firing Pin Safety Spring			
5509	Extractor			
5243	Extractor Depressor Plunger			
119	Extractor Depressor Plunger Spring			
126	Spring Loaded Bearing			
133	Slide Cover Plate			
182	Fixed Rear Sight 6.5mm			
154	Fixed Rear Sight 6.1mm			
196	Fixed Rear Sight 6.9mm			
210	Fixed Rear Sight 7.3mm			
791	Click Adjustable Rear Sight			
224	Front Sight			
5390	Receiver (Frame)			
280	Magazine Catch Spring			
1981	Extended Magazine Catch			
5446	Slide Lock Spring			
301	Slide Lock			
5264	Locking Block			
4431	Trigger Mechanism Housing with Ejector			
343	Connector (5 lb.) 2.5 kg (stand.)			
735	Connector (8 lb.) 3.5 kg			
350	Trigger Spring			
4417	Trigger with Trigger Bar			
5306	Slide Stop Lever with Spring			
420	Trigger Pin			
427	Trigger Mechanism Housing Pin			
3948	Follower			
448	Magazine Spring			
3941	Magazine Floor Plate with Hole			
6055	Magazine Insert			
3913	Magazine Tube			
483	Loading Device			
4523	Plastic Box for Pistol			
490	Cleaning Rod			
497	Cleaning Brush (Nylon)			
3661	New York Trigger Spring			
5418	New York Trigger Spring Plus			
4368	Locking Block Pin			
1148	Firing Pin Channel Liner			
	Other _____			
TOTAL				

GLOCK PARTS AND ACCESSORIES: GLOCK 21

PART NUMBER	GLOCK PISTOL DESCRIPTION	QTY. ORDERED	UNIT COST	TOTAL COST
5348	Slide			
5362	Barrel			
5586	Recoil Spring Assembly			
4557	Firing Pin			
56	Spacer Sleeve			
63	Firing Pin Spring			
70	Spring Cups			
4536	Firing Pin Safety			
91	Firing Pin Safety Spring			
5516	Extractor			
5243	Extractor Depressor Plunger			
119	Extractor Depressor Plunger Spring			
126	Spring Loaded Bearing			
133	Slide Cover Plate			
182	Fixed Rear Sight 6.5mm			
154	Fixed Rear Sight 6.1mm			
196	Fixed Rear Sight 6.9mm			
210	Fixed Rear Sight 7.3mm			
791	Click Adjustable Rear Sight			
224	Front Sight			
5390	Receiver (Frame)			
280	Magazine Catch Spring			
1981	Magazine Catch			
5446	Slide Lock Spring			
301	Slide Lock			
5264	Locking Block			
4431	Trigger Mechanism Housing with Ejector			
343	Connector (5 lb.) 2.5 kg (stand.)			
735	Connector (8 lb.) 3.5 kg			
350	Trigger Spring			
4417	Trigger with Trigger Bar			
5306	Slide Stop Lever with Spring			
420	Trigger Pin			
427	Trigger Mechanism Housing Pin			
3955	Follower			
448	Magazine Spring			
3941	Magazine Floor Plate with Hole			
5397	Magazine Insert			
3920	Magazine Tube			
483	Loading Device			
4529	Plastic Box for Pistol			
490	Cleaning Rod			
497	Cleaning Brush (Nylon)			
3661	New York Trigger Spring			
5418	New York Trigger Spring Plus			
4368	Locking Block Pin			
1148	Firing Pin Channel Liner			
	Other _____			
	TOTAL			

GLOCK PARTS AND ACCESSORIES: GLOCK 22

PART NUMBER	GLOCK PISTOL DESCRIPTION	QTY. ORDERED	UNIT COST	TOTAL COST
4487	Slide			
4452	Barrel			
1533	Recoil Spring Assembly			
4270	Firing Pin			
56	Spacer Sleeve			
63	Firing Pin Spring			
70	Spring Cups			
84	Firing Pin Safety			
91	Firing Pin Safety Spring			
98	Extractor			
112	Extractor Depressor Plunger			
119	Extractor Depressor Plunger Spring			
126	Spring Loaded Bearing			
133	Slide Cover Plate			
182	Fixed Rear Sight 6.5mm			
154	Fixed Rear Sight 6.1mm			
196	Fixed Rear Sight 6.9mm			
210	Fixed Rear Sight 7.3mm			
791	Click Adjustable Rear Sight			
224	Front Sight			
4438	Receiver (Frame)			
280	Magazine Catch Spring			
287	Magazine Catch			
1981	Extended Magazine Catch			
294	Slide Lock Spring			
301	Slide Lock			
4354	Locking Block			
4431	Trigger Mechanism Housing with Ejector			
343	Connector (5 lb.) 2.5 kg (stand.)			
735	Connector (8 lb.) 3.5 kg			
350	Trigger Spring			
357	Trigger with Trigger Bar			
4333	Slide Stop Lever with Spring			
420	Trigger Pin			
427	Trigger Mechanism Housing Pin			
3962	Follower			
448	Magazine Spring			
455	Magazine Floor Plate with Hole			
5166	Magazine Insert			
3927	Magazine Tube			
483	Loading Device			
4200	Plastic Box for Pistol			
490	Cleaning Rod			
497	Cleaning Brush (Nylon)			
4368	Locking Block Pin			
3661	New York Trigger Spring			
5418	New York Trigger Spring Plus			
1148	Firing Pin Channel Liner			
	Other _____			
	TOTAL			

GLOCK PARTS AND ACCESSORIES: GLOCK 23

PART NUMBER	GLOCK PISTOL DESCRIPTION	QTY. ORDERED	UNIT COST	TOTAL COST
4501	Slide			
4466	Barrel			
2457	Recoil Spring Assembly			
4270	Firing Pin			
56	Spacer Sleeve			
63	Firing Pin Spring			
70	Spring Cups			
84	Firing Pin Safety			
91	Firing Pin Safety Spring			
98	Extractor			
112	Extractor Depressor Plunger			
119	Extractor Depressor Plunger Spring			
126	Spring Loaded Bearing			
133	Slide Cover Plate			
182	Fixed Rear Sight 6.5mm			
154	Fixed Rear Sight 6.1mm			
196	Fixed Rear Sight 6.9mm			
210	Fixed Rear Sight 7.3mm			
791	Click Adjustable Rear Sight			
224	Front Sight			
4445	Receiver (Frame)			
280	Magazine Catch Spring			
287	Magazine Catch			
1981	Extended Magazine Catch			
2317	Slide Lock Spring			
301	Slide Lock			
4361	Locking Block			
4431	Trigger Mechanism Housing with Ejector			
343	Connector (5 lb.) 2.5 kg (stand.)			
735	Connector (8 lb.) 3.5 kg			
350	Trigger Spring			
2303	Trigger with Trigger Bar			
4333	Slide Stop Lever with Spring			
420	Trigger Pin			
427	Trigger Mechanism Housing Pin			
3962	Follower			
2429	Magazine Spring			
455	Magazine Floor Plate with Hole			
5166	Magazine Insert			
3934	Magazine Tube			
483	Loading Device			
4200	Plastic Box for Pistol			
490	Cleaning Rod			
497	Cleaning Brush (Nylon)			
4368	Locking Block Pin			
3661	New York Trigger Spring			
5418	New York Trigger Spring Plus			
1148	Firing Pin Channel Liner			
	Other _____			
	TOTAL			

Notes:



**Europe, Africa,
Middle East**

GLOCK Ges.m.b.H.
P.O. Box 50
A-2232 Deutsch-Wagram, Austria
Tel. (43) 2247-2460
Fax. (43) 2247-2460/12
Tlx. 133 307 glock a

USA, Canada

GLOCK, Inc.
6000 Highlands Parkway
Smyrna, GA 30082 USA
Tel. (404) 432-1202
Fax. (404) 433-8719
Tlx. 543353 glock atl ud

Asia, Australia

GLOCK (H.K.) Ltd.
No. 1, Ma War Road, Tai Po
New Territories, Hong Kong
Tel. (852) 657-2868
Fax. (852) 654-7089

**Latin America,
Central America,
Caribbean**

GLOCK AMERICA S.A.
Apurto Aereo 50661
Caracas 1050-A, Venezuela
Tel. (502) 98-60322, 61889, 75590
Fax. (582) 98-69512
Tlx. 27943 leger vc

GLOCK, Inc., P.O.Box 369,
Smyrna, Georgia 30081, U.S.A.

Fax (770) 433-8719
Tel. (770) 319-4789

Bulletin # 2-1-96

TECHNICAL BULLETIN

DATE: February 6, 1996
TO: All Glock Armors, Sales Managers and Glock Instructors
FROM: W. C. Haberland, Manager
Technical Customer Service
SUBJECT: New York Trigger Springs

The new New York Trigger springs will have a coil spring instead of a leaf spring type.

The New York #1 trigger spring, part # SPO 7405, will be olive drab in color and will be used in place of the standard New York trigger spring, part # SPO 3661 which has been discontinued.

The New York #2 trigger spring, part # SPO 7412, will be orange in color and will be used in place of the New York+ trigger spring, part # SPO 5418 which has been discontinued.

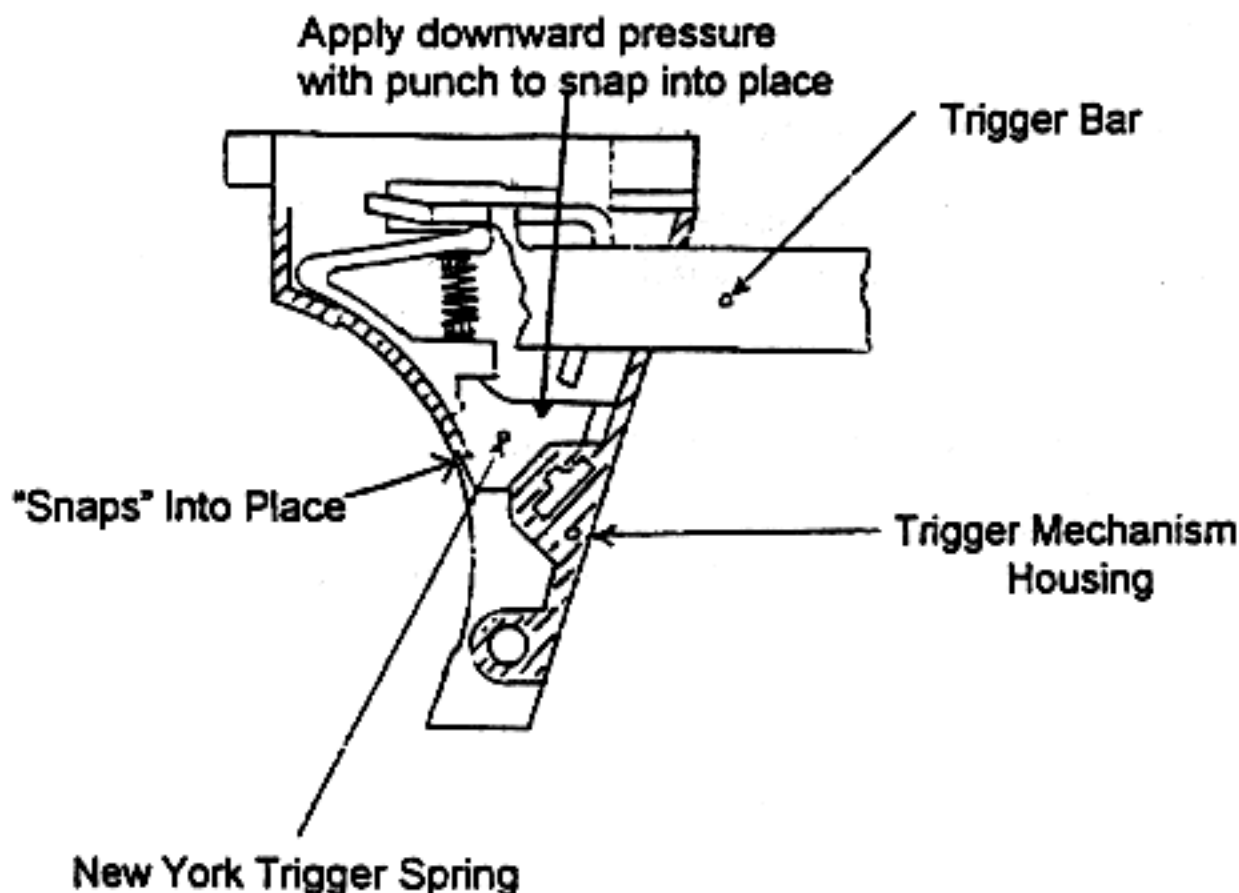

1. Detail strip the pistol frame (trigger assembly)
2. Remove trigger bar
3. Remove coil trigger spring
4. Insert New York trigger spring
5. Reinsert trigger bar over New York trigger spring
6. Reassemble frame and slide

NOTE: This operation should only be performed by a certified Glock Armorer. As always, a function test firing should occur with the individual firearm to assure proper functioning.

EXTRACTORS

When ordering extractors, the serial number of the pistol for which the extractor is ordered must be checked to determine if the extractor with the 90° or 15° should be shipped.

All GLOCK pistols starting with the following serial number prefixes have a 15° breech face and require a 15° extractor. The 9 mm and the 10 mm have a parallel hook. The 40 caliber and 45 caliber have a 5° hook. All 40 caliber pistols should have the new style 14.7 mm ejectors, parts # SP 01882.

<u>Model</u>	<u>Serial No. Prefix</u>	<u>Import Date</u>
G17	BKK	05/95
G17L	BMD	07/95
G19	BKP	05/95
G20	BMR	09/95
G21	ALD	05/93
G22	BKD	05/95
G23	BKH	05/95
G24/24C	BMD	06/95
G26	BMX	07/95
G27	BMV	07/95

9 mm G17/17L/19/26

All 9 mm use trigger housing with ejector part # SP 00322.
All 9 mm use ejector part # SP 00336.

90° Breech Face - Extractor # SP 00098 - 90°/Parallel Hook
15° Breech Face - Extractor # SP 01889 - 15°/Parallel Hook

40 Caliber G22/23/24/24p/27

All 40 calibers use trigger housing with ejector part # SP 01896.
All 40 Calibers use ejector part # SP 01882 (new style).

90° Breech Face - Extractor # SP 06908 - 90°/5°
15° Breech Face - Extractor # SP 06740 - 15°/5°

10 mm G20

All 10 mm use trigger housing with ejector part # SP 04431.
All 10 mm use ejector part # SP 04340.

90° Breech Face - Extractor # SP 05509 - 90°/Parallel Hook
15° Breech Face - Extractor # SP 06061 - 15°/Parallel Hook

45 ACP G21

All 45 ACP use trigger housing with ejector part # SP 04431.
All 45 ACP use ejector part # SP 04340.

90° Breech Face - Ship to GLOCK Smyrna to be cut to 15°
15° Breech Face - Extractor # SP 05516 - 15°/5°

Modified Dissassembly Tool - ST 03374 - Used to remove the ejector from the trigger mechanism housing.

UPGRADE

On pistols subject to the firing pin system upgrade, you can determine if the upgrade has been conducted by checking the following parts:

- Trigger with trigger bar
- Extractors
- Firing Pin
- Firing Pin Safety
- Firing Pin Safety Spring
- Spring Loaded Bearing

The following is a list of serial numbers that are affected by the upgrade. We recommend that all pistols in the following serial number ranges should have the product upgrade.

- Glock 17 Pistols - Alphabetical Prefix through XG
- Glock 19 Pistols - Alphabetical Prefix through XK
- Glock 20 Pistols - Alphabetical Prefix through WX
- Glock 21 Pistols - Alphabetical Prefix through XM
- Glock 22 Pistols - Alphabetical Prefix through YB
- Glock 23 Pistols - Alphabetical Prefix through SL

All three letter prefix pistols already have the product upgrade parts.

G21 45 ACP

All pistols prior to serial number ALD should come to GLOCK to have the slide modifications, i.e. the pickup rail is radiused and the right rear edge of the ejection port is angled.

A B C D E F G H I J K L M N O P Q R S T U V W X Y Z

MAGAZINES

When the following magazine parts are ordered and a specific part number is not specified, the customer must be contacted to find out what type of magazine is involved. Following is a list of information needed in order to determine exactly what the customer needs:

9 m/m - All

Non-Full Metal Lined

Floor Plate - SP 00455
Magazine Insert - SP 05572
Orange Floor Plate - SP 02373

Full Metal Lined

Floor Plate - SP 03206
Magazine Insert - SP 01693
Orange Floor Plate - SP 01294

40 Caliber - All

Non-Full Metal Lined

Floor Plate - SP 00455
Magazine Insert - SP 05166
Orange Floor Plate - SP 02373

Full Metal Lined

Floor Plate - SP 03206
Magazine Insert - SP 05166
Orange Floor Plate - SP 01294

10 mm - All

Non-Full Metal Lined

Floor Plate - SP 03941
Magazine Insert - SP 06055
Orange Floor Plate - SP 02681

Full Metal Lined

Floor Plate - SP 03941
Magazine Insert - SP 06055
Orange Floor Plate - SP 02681

45 Caliber - G21 - All

Non-Full Metal Lined

Floor Plate - SP 03941
Magazine Insert - SP 05397
Orange Floor Plate - SP 02681

Full Metal Lined

Floor Plate - SP 03941
Magazine Insert - SP 05397
Orange Floor Plate - SP 02681

45 Caliber - G30

Non-Full Metal Lined

N/A

Full Metal Lined

Floor Plate - SP 03941 - 9 Round
Floor Plate - SP 08189 - 10 Round
Mag Insert - SP 06901 - 9 Round
Mag Insert - SP 06901 - 10 Round

MAGAZINE SPRINGS

When ordering magazine springs, you must find out what model the magazines are used for and whether they are high capacity or 10 round magazines. Following is a list of part order numbers for magazine springs:

<u>9 Round</u>	<u>10 Round</u>	<u>High Capacity</u>
G30 - SP02429	G17 - SP 02309	G17 - SP 00448
	G17L - SP 02309	G17L - SP 00448
	G19 - SP 02316	G19 - SP 02429
	G20 - SP 02323	G20 - SP 00448
	G21 - SP 00448	G21 - SP 00448
	G22 - SP 02323	G22 - SP 00448
	G23 - SP 02429	G23 - SP 02429
	G24 - SP 02323	G24 - SP 00448
	G29 - SP 02429	
	G30 - SP 02429	

The Glock Model 26/27 magazines take the same style magazine spring, part # SP 02429.

FOLLOWERS

<u>Model</u>	<u>Type</u>	<u>Part #</u>	<u>Followers Marked With</u>
G17	High Capacity	SP 01812	MM1
G17	10 Round	SP 02183	MM1
G19	High Capacity	SP 01812	MM1
G19	10 Round	SP 02183	MM1
G20	High Capacity	SP 03948	
G20	10 Round	SP 03948	
G21	High Capacity	SP 03955	
G21	10 Round	SP 03955	
G22	High Capacity	SP 01028	5
G22	10 Round	SP 01028	5
G23	High Capacity	SP 01028	5
G23	10 Round	SP 01028	5
G26	All Magazines	SP 01812	MM1
G27	All Magazines	SP 01028	5
G29	All Magazines	SP 03948	
G30	9 Round	SP 03955	
G30	10 Round	SP 03955	

THREE GENERATIONS OF GLOCK MAGS

NON-FULL
METAL LINED

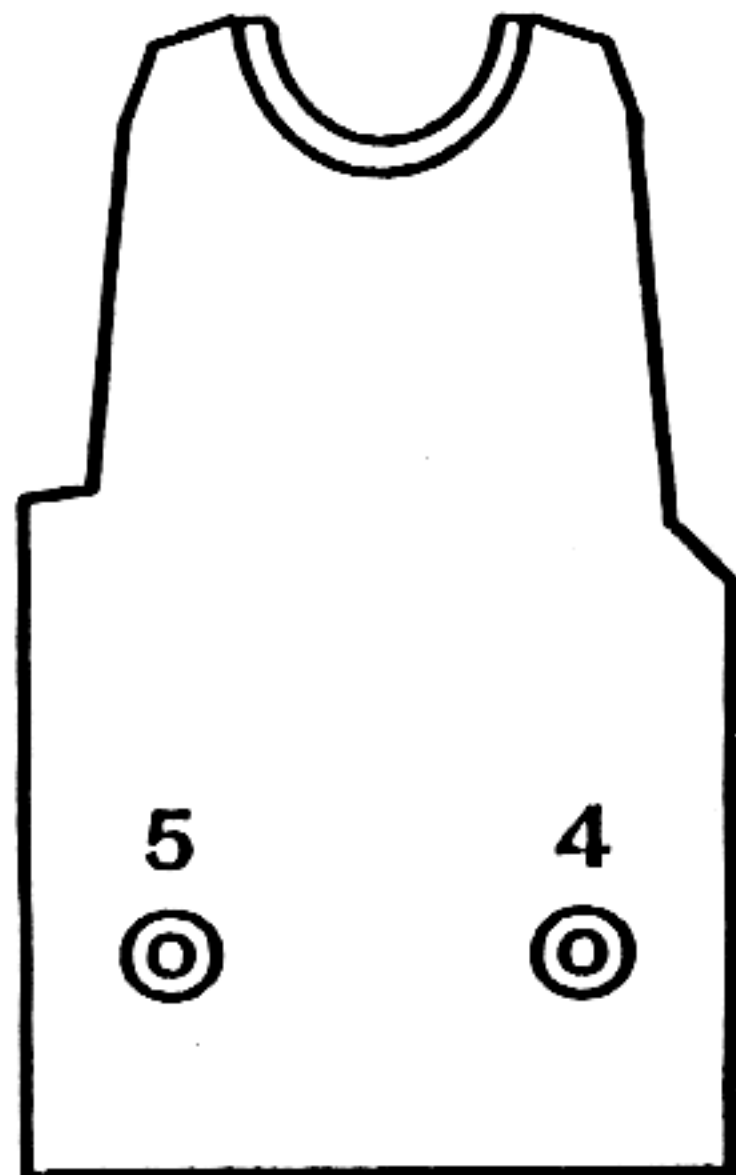

FULL METAL
LINED

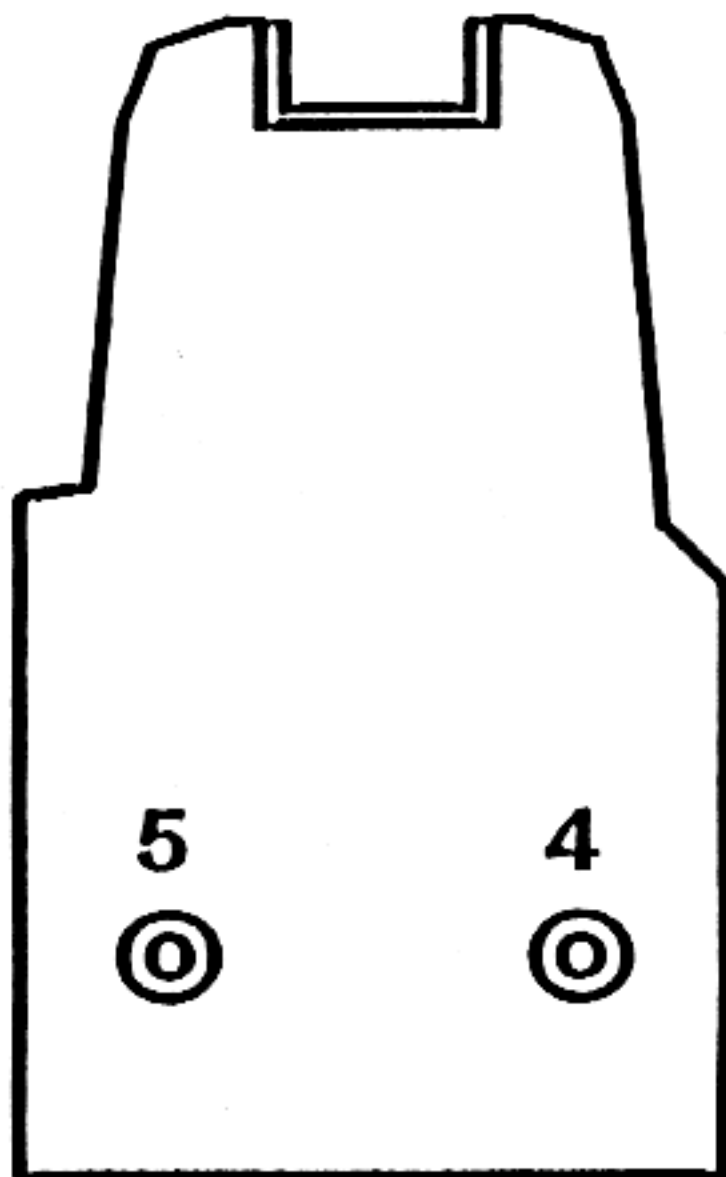

FULL METAL
LINED

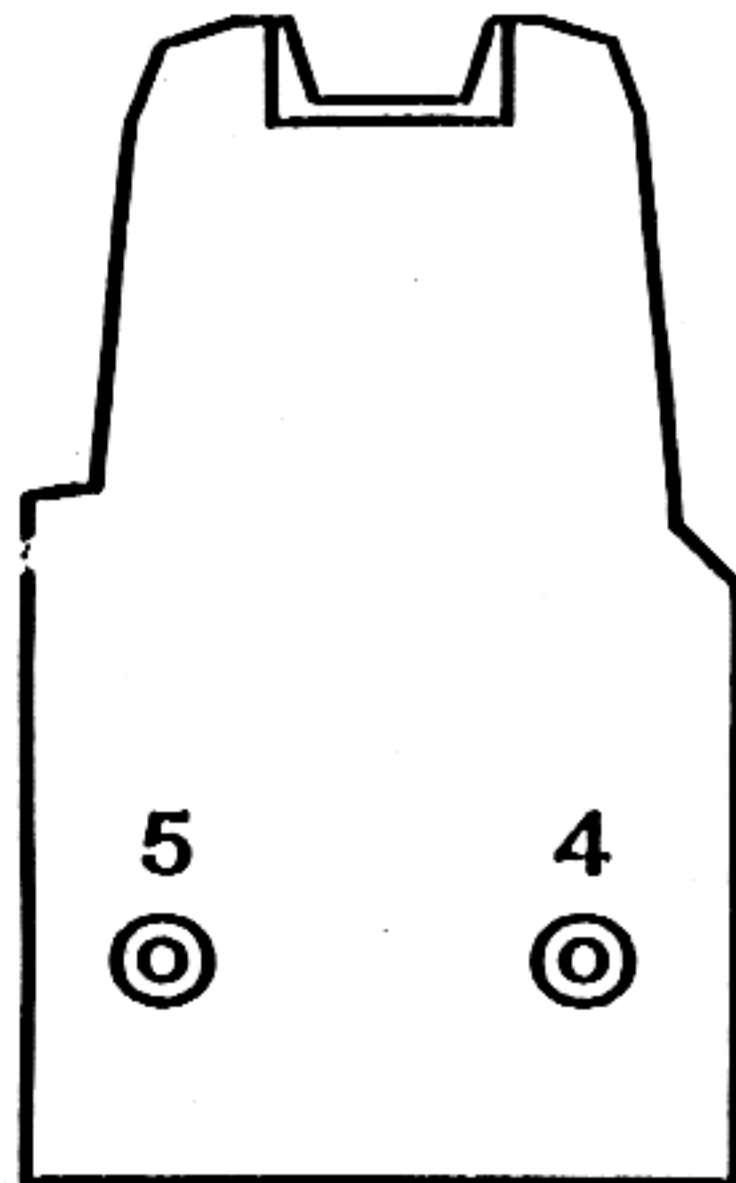

Top View of Glock Slides

90° Breach Face

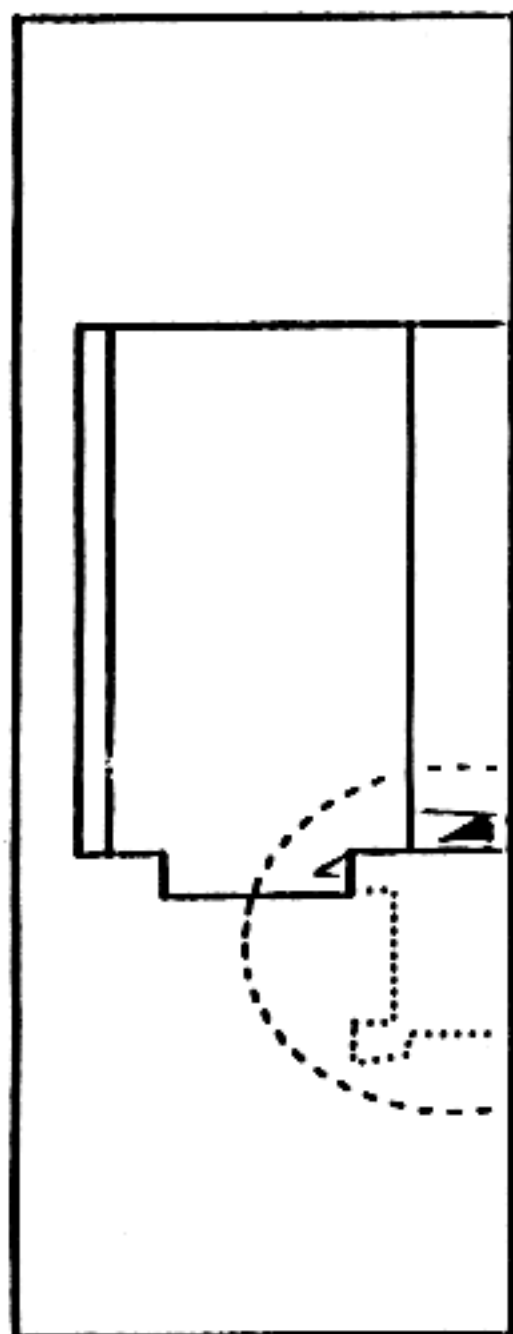

15° Breach Face

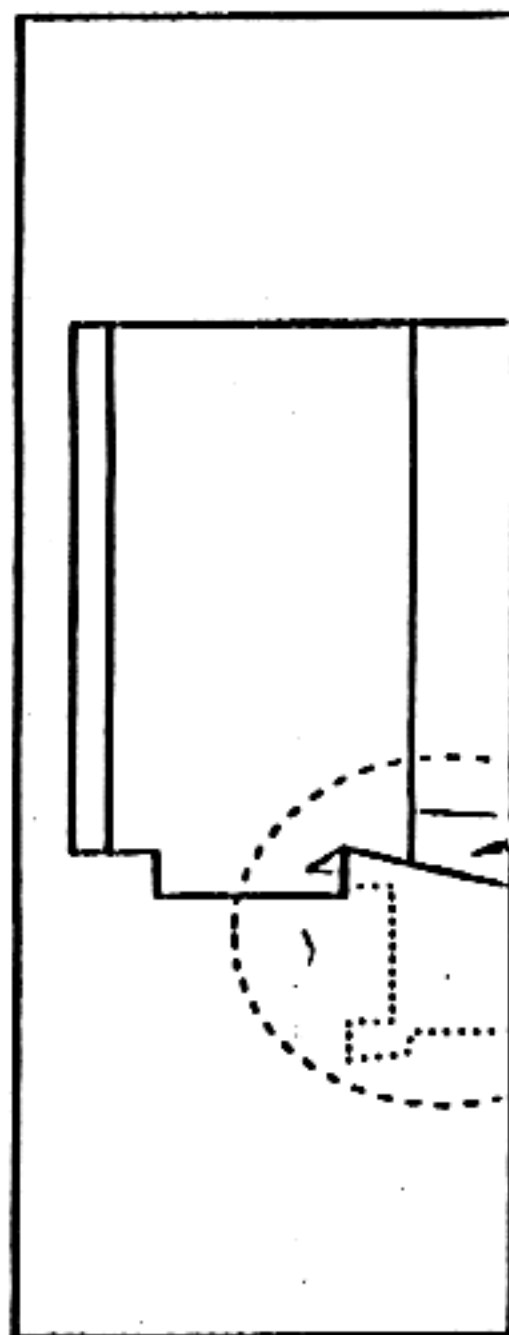

90° Cut

15° Cut

90° \ Parallel Hook

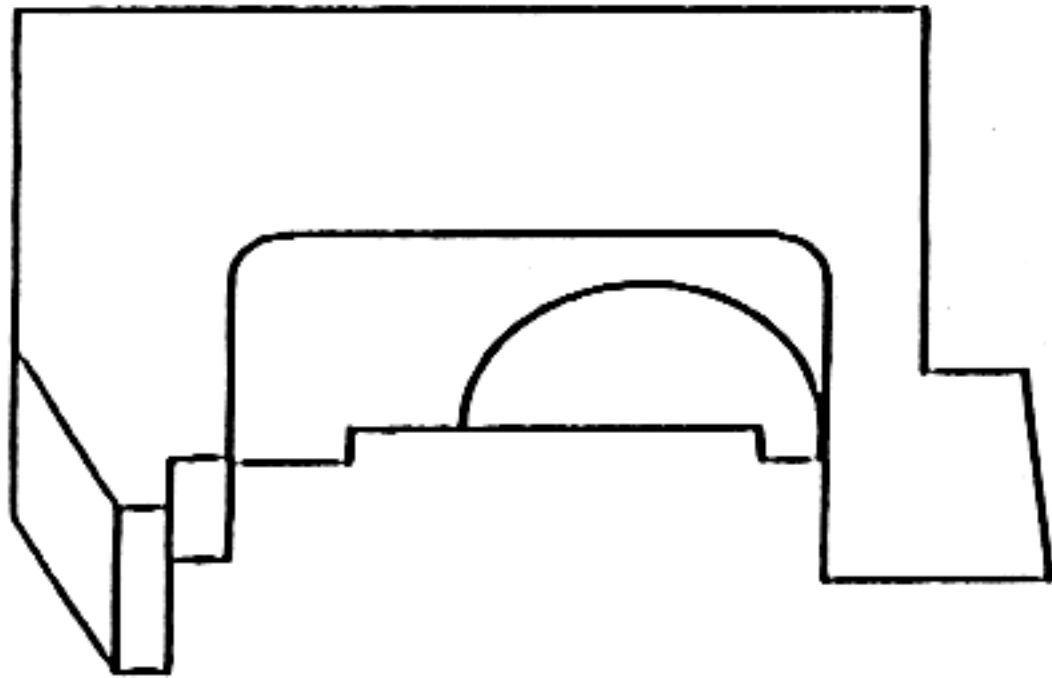

15° \ Parallel Hook

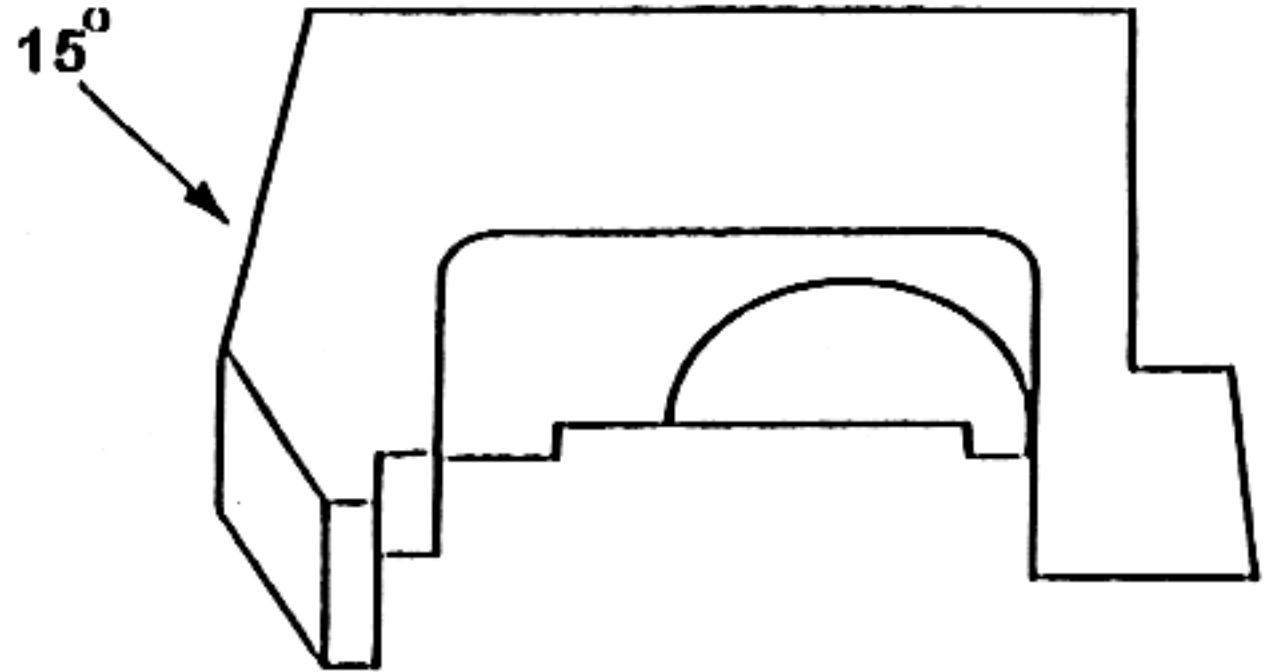

90° \ 5°

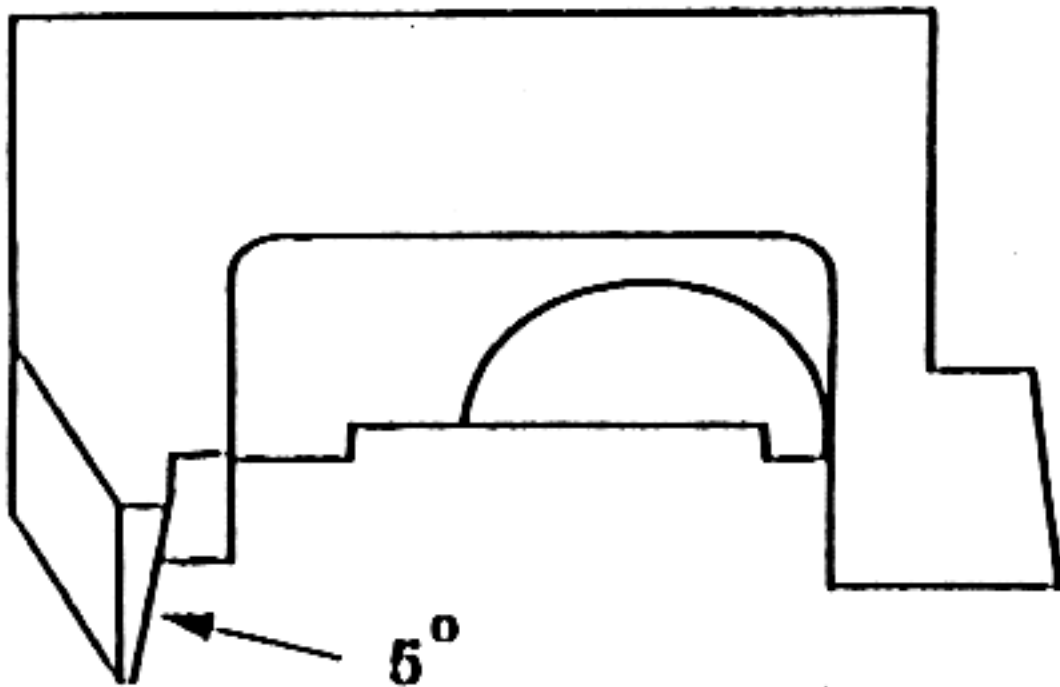

15° \ 5°

